

Table of Contents

Introduction	4
Instrument Cluster	10
Warning and control lights	10
Gauges	14
Entertainment Systems	16
AM/FM stereo cassette	16
AM/FM stereo with CD	19
Climate Controls	34
Heater only	34
Manual heating and air conditioning	35
Rear window defroster	37
Lights	38
Headlamps	38
Turn signal control	42
Driver Controls	50
Windshield wiper/washer control	50
Steering wheel adjustment	51
Power windows	53
Mirrors	53
Speed control	54
Locks and Security	62
Keys	62
Locks	62
Anti-theft system	65

Table of Contents

Seating and Safety Restraints	72
Seating	72
Safety restraints	77
Air bags	90
Child restraints	96
Driving	108
Starting	108
Brakes	112
Traction control	114
Transmission operation	115
Vehicle loading	121
Trailer towing	124
Recreational towing	126
Roadside Emergencies	127
Getting roadside assistance	127
Hazard flasher switch	128
Fuel pump shut-off switch	128
Fuses and relays	129
Changing tires	137
Jump starting	141
Wrecker towing	148
Customer Assistance	149
Reporting safety defects (U.S. only)	158
Cleaning	159

Table of Contents

Maintenance and Specifications	165
Engine compartment	167
Engine oil	170
Battery	174
Fuel information	182
Tire Information	197
Part numbers	209
Refill capacities	210
Lubricant specifications	212
Accessories	220
Index	222

All rights reserved. Reproduction by any means, electronic or mechanical including photocopying, recording or by any information storage and retrieval system or translation in whole or part is not permitted without written authorization from Ford Motor Company. Ford may change the contents without notice and without incurring obligation.

Copyright © 2003 Ford Motor Company

Introduction

CALIFORNIA Proposition 65 Warning



WARNING: Engine exhaust, some of its constituents, and certain vehicle components contain or emit chemicals known to the State of California to cause cancer and birth defects or other reproductive harm. In addition, certain fluids contained in vehicles and certain products of component wear contain or emit chemicals known to the State of California to cause cancer and birth defects or other reproductive harm.

CONGRATULATIONS

Congratulations on acquiring your new Ford. Please take the time to get well acquainted with your vehicle by reading this handbook. The more you know and understand about your vehicle, the greater the safety and pleasure you will derive from driving it.

For more information on Ford Motor Company and its products visit the following website:

- In the United States: www.ford.com
- In Canada: www.ford.ca
- In Australia: www.ford.com.au
- In Mexico: www.ford.com.mx

Additional owner information is given in separate publications.

This *Owner's Guide* describes every option and model variant available and therefore some of the items covered may not apply to your particular vehicle. Furthermore, due to printing cycles it may describe options before they are generally available.

Remember to pass on this *Owner's Guide* when reselling the vehicle. It is an integral part of the vehicle.



Fuel pump shut-off switch: In the event of an accident the safety switch will automatically cut off the fuel supply to the engine. The switch can also be activated through sudden vibration (e.g. collision when parking). To reset the switch, refer to the *Fuel pump shut-off switch* in the *Roadside Emergencies* chapter.

SAFETY AND ENVIRONMENT PROTECTION

Warning symbols in this guide

How can you reduce the risk of personal injury and prevent possible damage to others, your vehicle and its equipment? In this guide, answers to such questions are contained in comments highlighted by the warning triangle symbol. These comments should be read and observed.

Warning symbols on your vehicle

When you see this symbol, it is imperative that you consult the relevant section of this guide before touching or attempting adjustment of any kind.



Protecting the environment

We must all play our part in protecting the environment. Correct vehicle usage and the authorized disposal of waste, cleaning and lubrication materials are significant steps towards this aim. Information in this respect is highlighted in this guide with the tree symbol.



BREAKING-IN YOUR VEHICLE

Your vehicle does not need an extensive break-in. Try not to drive continuously at the same speed for the first 1,000 miles (1,600 km) of new vehicle operation. Vary your speed to allow parts to adjust themselves to other parts.

Do not add friction modifier compounds or special break-in oils during the first few thousand miles (kilometers) of operation, since these additives may prevent piston ring seating. See *Engine oil* in the *Maintenance and Specifications* chapter for more information on oil usage.

Introduction

SPECIAL NOTICES

Emission warranty

The New Vehicle Limited Warranty includes Bumper-to-Bumper Coverage, Safety Restraint Coverage, Corrosion Coverage, and 6.0L Power Stroke Diesel Engine Coverage. In addition, your vehicle is eligible for Emissions Defect and Emissions Performance Warranties. For a detailed description of what is covered and what is not covered, refer to the *Warranty Guide* that is provided to you along with your Owner's Guide.

Special instructions

For your added safety, your vehicle is fitted with sophisticated electronic controls.



Please read the section *Supplemental restraint system (SRS)* in the *Seating and Safety Restraints* chapter. Failure to follow the specific warnings and instructions could result in personal injury.



Front seat mounted rear-facing child or infant seats should **NEVER** be placed in front of an active passenger air bag.

Service Data Recording

Service data recorders in your vehicle are capable of collecting and storing diagnostic information about your vehicle. This potentially includes information about the performance or status of various systems and modules in the vehicle, such as engine, throttle, steering or brake systems. In order to properly diagnose and service your vehicle, Ford Motor Company, Ford of Canada, and service and repair facilities may access vehicle diagnostic information through a direct connection to your vehicle when diagnosing or servicing your vehicle.

Introduction

Event Data Recording

Other modules in your vehicle — event data recorders — are capable of collecting and storing data during a crash or near crash event. The recorded information may assist in the investigation of such an event. The modules may record information about both the vehicle and the occupants, potentially including information such as:

- how various systems in your vehicle were operating;
- whether or not the driver and passenger seatbelts were buckled;
- how far (if at all) the driver was depressing the accelerator and/or the brake pedal;
- how fast the vehicle was traveling; and
- where the driver was positioning the steering wheel.

To access this information, special equipment must be directly connected to the recording modules. Ford Motor Company and Ford of Canada do not access event data recorder information without obtaining consent, unless pursuant to court order or where required by law enforcement, other government authorities or other third parties acting with lawful authority. Other parties may seek to access the information independently of Ford Motor Company and Ford of Canada.

MIDDLE EAST/NORTH AFRICA VEHICLE SPECIFIC INFORMATION

For your particular global region, your vehicle may be equipped with features and options that are different from the ones that are described in this *Owner's Guide*; therefore, a supplement has been supplied that complements this book. By referring to the pages in the provided supplement, you can properly identify those features, recommendations and specifications that are unique to your vehicle. **Refer to this Owner's Guide for all other required information and warnings.**

Introduction











These are some of the symbols you may see on your vehicle.

Vehicle Symbol Glossary

Safety Alert		See Owner's Guide	
Fasten Safety Belt		Air Bag-Front	
Air Bag-Side		Child Seat	
Child Seat Installation Warning		Child Seat Lower Anchor	
Child Seat Tether Anchor		Brake System	
Anti-Lock Brake System		Brake Fluid - Non-Petroleum Based	
Traction Control		AdvanceTrac [™]	
Master Lighting Switch		Hazard Warning Flasher	
Fog Lamps-Front		Fuse Compartment	
Fuel Pump Reset		Windshield Wash/Wipe	
Windshield Defrost/Demist		Rear Window Defrost/Demist	

Introduction

Vehicle Symbol Glossary

Power Windows Front/Rear		Power Window Lockout	
Child Safety Door Lock/Unlock		Interior Luggage Compartment Release Symbol	
Panic Alarm		Engine Oil	
Engine Coolant		Engine Coolant Temperature	
Do Not Open When Hot		Battery	
Avoid Smoking, Flames, or Sparks		Battery Acid	
Explosive Gas		Fan Warning	
Power Steering Fluid		Maintain Correct Fluid Level	
Emission System		Engine Air Filter	
Passenger Compartment Air Filter		Jack	
Check fuel cap		Low tire warning	

Instrument Cluster

WARNING LIGHTS AND CHIMES

Standard instrument cluster

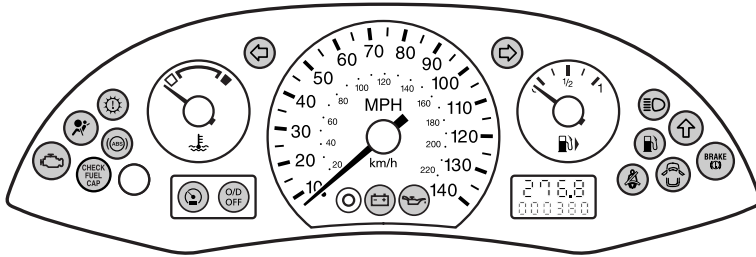

Optional instrument cluster

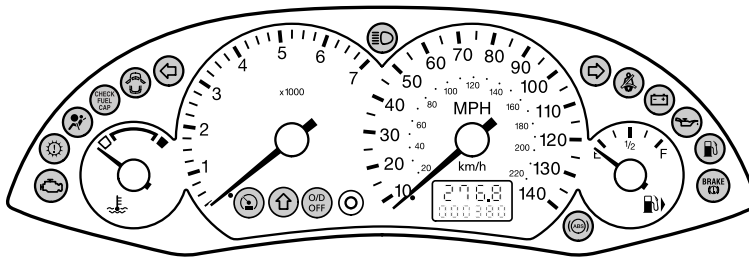

2.3L 14 PZEV instrument cluster

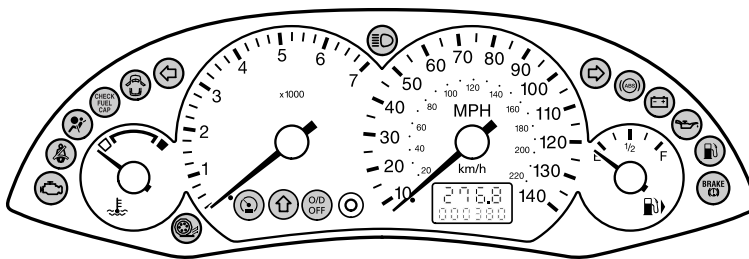

Warning lights and gauges can alert you to a vehicle condition that may become serious enough to cause expensive repairs. A warning light may illuminate when a problem exists with one of your vehicle's functions.

Instrument Cluster

Many lights will illuminate when you start your vehicle to make sure the bulb works. If any light remains on after starting the vehicle, have the respective system inspected immediately.

Check engine: The *Check Engine* indicator light illuminates when the ignition is first turned to the ON position to check the bulb. Solid

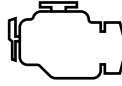

illumination after the engine is started indicates the On Board Diagnostics System (OBD-II) has detected a malfunction. Refer to *OBD-II* in the *Maintenance and Specifications* chapter. If the light is blinking, engine misfire is occurring which could damage your catalytic converter. Drive in a moderate fashion (avoid heavy acceleration and deceleration) and have your vehicle serviced immediately.



Under engine misfire conditions, excessive exhaust temperatures could damage the catalytic converter, the fuel system, interior floor coverings or other vehicle components, possibly causing a fire.

Check fuel cap: Illuminates when the fuel cap may not be properly installed. Continued driving with this light on may cause the Check engine warning light to come on, refer to *Fuel filler cap* in the *Maintenance and Specification* chapter.

**CHECK
FUEL
CAP**

Brake system warning light: To confirm the brake system warning light is functional, it will momentarily illuminate when the

**BRAKE
(!)**

ignition is turned to the ON position when the engine is not running, or in a position between ON and START, or by applying the parking brake when the ignition is turned to the ON position. If the brake system warning light does not illuminate at this time, seek service immediately from your dealership. Illumination after releasing the parking brake indicates low brake fluid level and the brake system should be inspected immediately by your servicing dealership.

Instrument Cluster



Driving a vehicle with the brake system warning light on is dangerous. A significant decrease in braking performance may occur. It will take you longer to stop the vehicle. Have the vehicle checked by your dealer immediately.

Anti-lock brake system: If the ABS light stays illuminated or continues to flash, a malfunction has been detected, have the system serviced immediately. Normal braking is still functional unless the brake warning light also is illuminated.



Air bag readiness: If this light fails to illuminate when ignition is turned to ON, continues to flash or remains on, have the system serviced immediately. A chime will also sound when a malfunction in the supplemental restraint system has been detected.



Safety belt: Reminds you to fasten your safety belt. A chime will also sound to remind you to fasten your safety belt.



Charging system: Illuminates when the battery is not charging properly.



Engine oil pressure: Illuminates when the oil pressure falls below the normal range, refer to *Engine oil* in the *Maintenance and specifications* chapter.



Multi-function: Automatic transaxle/cooling system (On SPI, Zetec E or automatic transaxle vehicles only):



Momentarily illuminates when the ignition is turned to the ON position and the engine is off. If the light illuminates while driving, have your vehicle serviced.

Instrument Cluster

Overdrive off (if equipped):

Illuminates when the overdrive function of the transaxle has been turned off, refer to the *Driving* chapter. If the light flashes steadily or does not illuminate, have the transmission serviced soon, or damage may occur.

O/D
OFF

Upshift (if equipped): To maximize fuel economy, this light illuminates when the manual transmission should be shifted to the next highest gear. Refer to the *Driving* chapter for more information.



Traction Control™ system (if equipped): Illuminates when the Traction Control™ is turned OFF and will flash when active. If the light remains on, have the system serviced immediately, refer to the *Driving* chapter for more information.



Low fuel: Illuminates when the fuel level in the fuel tank is at or near empty (refer to *Fuel gauge* in this chapter).



Speed control (if equipped):

Illuminates when the speed control is activated. Turns off when the speed control system is deactivated, refer to the *Driver Controls* chapter for more information.



Door ajar: Illuminates when the ignition is in the ON position and any door is open.



Turn signal: Illuminates when the left or right turn signal or the hazard lights are turned on. If the indicators stay on or flash faster, check for a burned out bulb.



Instrument Cluster

High beams: Illuminates when the high beam headlamps are turned on.



Key-in-ignition warning chime: Sounds when the key is left in the ignition in the OFF/LOCK or ACCESSORY position and the driver's door is opened.

Headlamps on warning chime: Sounds when the headlamps or parking lamps are on, the ignition is off (the key is not in the ignition) and the driver's door is opened.

Gearshift warning chime (automatic transaxle only): Sounds when the gearshift lever is not in P (Park) and the driver's door is opened.

GAUGES

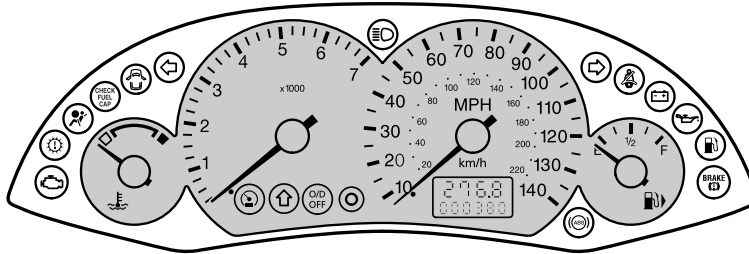

Speedometer: Indicates the current vehicle speed.

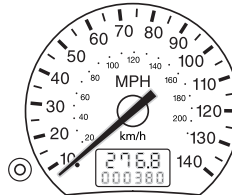

Engine coolant temperature gauge: Indicates engine coolant temperature. At normal operating temperature, the needle will be in the normal range (between "H" and "C"). **If it enters the red section, the engine is overheating. Stop the vehicle as soon as safely possible, switch off the engine and let the engine cool.** If it enters

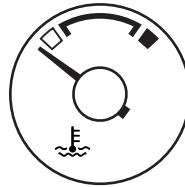

Instrument Cluster

the red section and the *Check Engine* indicator light illuminates, refer to *How fail safe cooling works in coolant* in the *Maintenance and Specifications* chapter.



Never remove the coolant reservoir cap while the engine is running or hot.

Odometer: Registers the total kilometers (miles) of the vehicle.

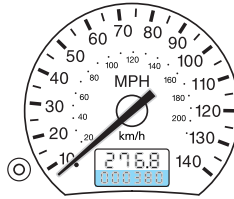

Trip odometer: Registers the kilometers (miles) of individual journeys. To reset, depress the reset control.

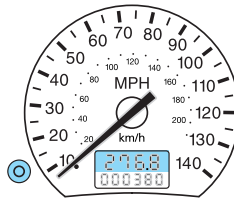

Tachometer (if equipped): Indicates the engine speed in revolutions per minute. Driving with your tachometer pointer continuously at the top of the scale may damage the engine.

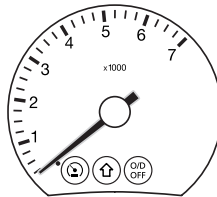

Fuel gauge: Indicates approximately how much fuel is left in the fuel tank (when the ignition is in the ON position). The fuel gauge may vary slightly when the vehicle is in motion or on a grade.

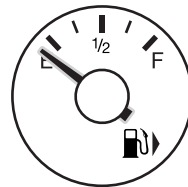

Refer to *Filling the tank* in the *Maintenance and Specifications* chapter for more information.

Entertainment Systems

AM/FM STEREO WITH CASSETTE (IF EQUIPPED)

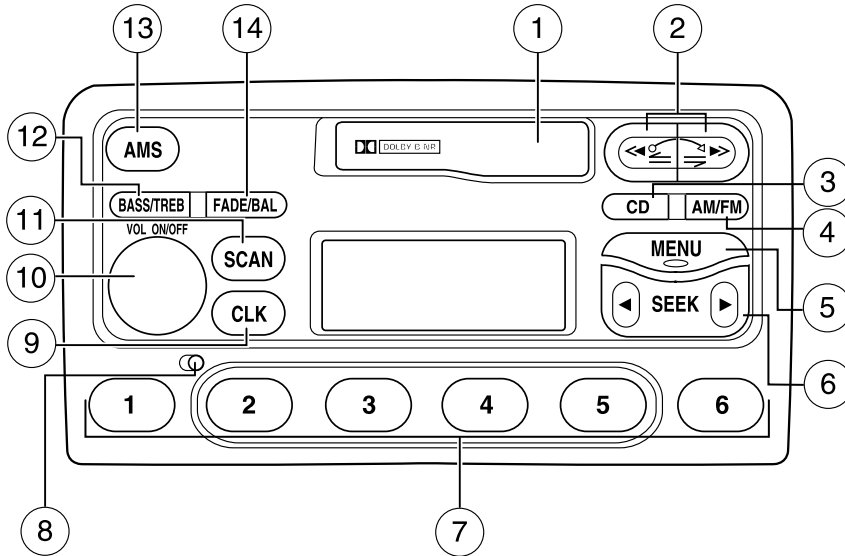

1. **Cassette door:** Insert the cassette with the opening to the right.

2. **Rewind/fast forward:** Press to reverse/advance to the previous/next cassette selection. If the end of the tape is reached, playback begins on the other side. Partially press both to change tape sides.

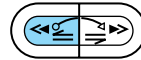

Eject: Fully press both controls to eject the tape.

3. **CD:** Press to engage CDDJ (if equipped) mode. CDs and tracks are selected and played chronologically. Press AM/FM to restore radio reception without ejecting the disc.



4. **AM/FM:** Press to toggle between AM/FM1/FM2 frequency bands and or press to stop CDDJ (if equipped) play.

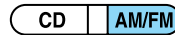

Entertainment Systems

5. **Menu:** Press MENU to access main menu functions. Use SEEK ▲ / ▼ for adjustments.



Tune adjust: Press MENU until MAN appears in the display. Press ◀ or ▶ to manually move down/up the radio frequency band.

Dolby: Dolby® noise reduction reduces the amount of hiss and static during tape playback. Press MENU until the display appears. Use SEEK to turn on/off.

Dolby® noise reduction is manufactured under license from Dolby® Laboratories Licensing Corporation. “Dolby®” and the double-D symbol  are registered trademarks of Dolby® Laboratories Licensing Corporation.

Automatic volume control (AVC): Radio volume changes automatically with vehicle speed to compensate for road and wind noise. Press MENU until AVC is displayed, then use the SEEK ◀ / ▶ control to adjust the levels.

6. **Seek** (reverse/fast forward):

Press and release SEEK ◀ / ▶ for previous (reverse)/next (fast forward) strong station or CD track (if equipped).



7. **Memory presets:** To set a station: Select frequency band AM/FM; tune to a station, press and hold a preset button until sound returns.

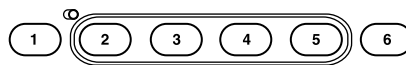

AutoStore: AutoStore allows you to set strong radio stations on the FM band without losing your original manually set preset stations. Press and hold AM/FM to activate. AST will flash in the display. When the six strongest stations are filled, the sound will be restored.

8. **Anti-theft protection panel:** To deter would-be thieves, Ford audio units have a removable front panel without which the unit will not work.

Avoid touching the contacts on the back of the panel and do not use excessive force to refit it.

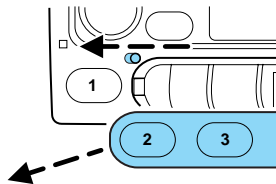

Entertainment Systems

Press the security release control and remove the front panel. To reposition the panel, insert the right-hand edge first, then the left-hand side, until the retaining latch is engaged.

Replacement panels: Your Ford Dealer will require the following if you need to order a replacement panel:

- Your name and address.
- The vehicle identification number (visible in the corner of the windscreen).
- The audio unit type.
- Proof of identification (i.e. driver's license).
- A vehicle invoice (if the audio unit was installed in the vehicle prior to delivery) or a parts invoice if the audio unit was purchased separately from the vehicle, or an appropriate vehicle registration document.

9. **Clock:** Press and hold CLK until the hour digit flashes. Turn the volume control to increase/decrease the hours. Press again to set the minutes. Turn the volume control to increase/decrease the minutes.



10. **Power/volume:** Press to turn ON/OFF; turn to increase or decrease volume levels. The display will indicate the level selected.

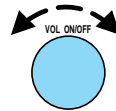

11. **Scan:** Press SCAN to hear a brief sampling of all listenable radio stations. Press again to stop.



12. **Bass/Treble:** Press once for bass, twice for treble. Turn the volume control to decrease/increase the output. The display will indicate the level selected.



13. **AMS** (Automatic Music Search):



Press to advance to the next tape selection.

14. **Fade/Balance:** Press once for fade and twice for balance. Turn the volume control to shift sound to the rear/front speakers, or to the left and right speakers.



Entertainment Systems

AM/FM STEREO WITH CD PLAYER (IF EQUIPPED)

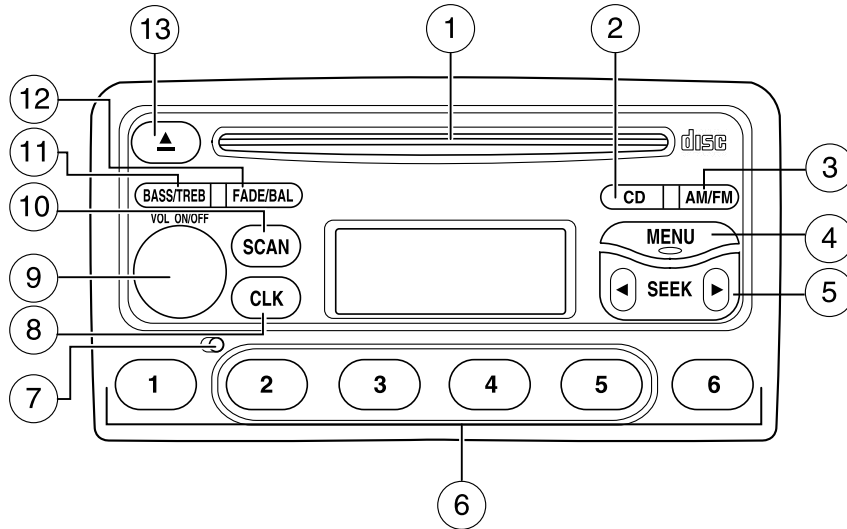

1. **CD door:** Insert the CD label side up.

2. **CD:** Press to engage CD mode. CDs and tracks are selected and played chronologically. Press the AM/FM control to restore radio reception without ejecting the disc.



3. **AM/FM:** Press to toggle between AM/FM1/FM2 frequency bands or to stop CD play.



4. **Menu:** Press MENU to access main menu functions. Use SEEK ▲ / ▼ for adjustments.



Tune adjust: Press MENU until MAN appears in the display. Press ◀ / ▶ to manually move down/up the radio frequency band.

Compression: Press MENU until COMP appears in the display. Press SEEK to engage/disengage the feature. Compression adjust brings soft and loud CD passages together for a more consistent listening level.

Entertainment Systems

Shuffle: Press MENU until SHUF appears in the display. Press SEEK to engage/disengage the feature. Shuffle plays the songs on the current CD in random order.

Automatic volume control (AVC): With this feature, radio volume changes automatically with vehicle speed to compensate for road and wind noise. Press MENU until AVC is displayed, then use the SEEK ◀ / ▶ control to adjust the volume.

5. **Seek** (reverse/fast forward): Press and release SEEK ◀ / ▶ for previous (reverse)/next (fast forward) strong station or CD track.



6. **Memory presets:** To set a station: Select frequency band AM/FM; tune to a station, press and hold a preset button until sound returns. With a CD, press the preset control that corresponds to the desired disc.

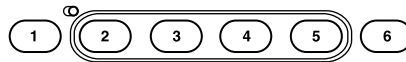

AutoStore: AutoStore allows you to set strong radio stations on the FM band without losing your original manually set preset stations. Press and hold AM/FM to activate. AST will flash in the display. When the six strongest stations are filled, the sound will be restored.

7. **Anti-theft protection panel:** To deter would-be thieves, Ford audio units have a removable front panel without which the unit will not work.

Avoid touching the contacts on the back of the panel and do not use excessive force to refit it.

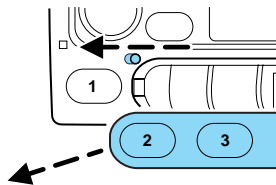

Press the security release control and remove the front panel. To reposition the panel, insert the right-hand edge first, then the left-hand side, until the retaining latch is engaged.

Replacement panels: Your Ford Dealer will require the following if you need to order a replacement panel:

- Your name and address.
- The vehicle identification number (visible in the corner of the windscreen).
- The audio unit type.
- Proof of identification (i.e. driver's license).

Entertainment Systems

- A vehicle invoice (if the audio unit was installed in the vehicle prior to delivery) or a parts invoice if the audio unit was purchased separately from the vehicle, or an appropriate vehicle registration document.

8. **Clock:** Press and hold until the hour digit flashes. Turn the volume control to increase/decrease the hours. Press again to set the minutes. Turn the volume control to increase/decrease the minutes.



9. **Power/volume:** Press to turn ON/OFF; turn to increase or decrease volume levels. The system may function for up to an hour after the ignition is turned off.

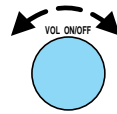

10. **Scan:** Press for a brief sampling of all listenable radio stations or CD tracks. Press again to stop.



11. **Bass/Treble:** Press once for bass, twice for treble. Turn the volume control to increase/decrease the output. The display will indicate the level selected.

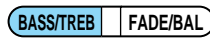

12. **Fade/Balance:** Press once for fade and twice for balance. Turn the volume control to shift sound to the rear/front speakers or to the left/right speakers.

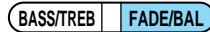

13. **Eject:** Press to eject the CD.



Entertainment Systems

6006 AM/FM SOUND SYSTEM WITH 6-DISC IN DASH CHANGER (IF EQUIPPED)

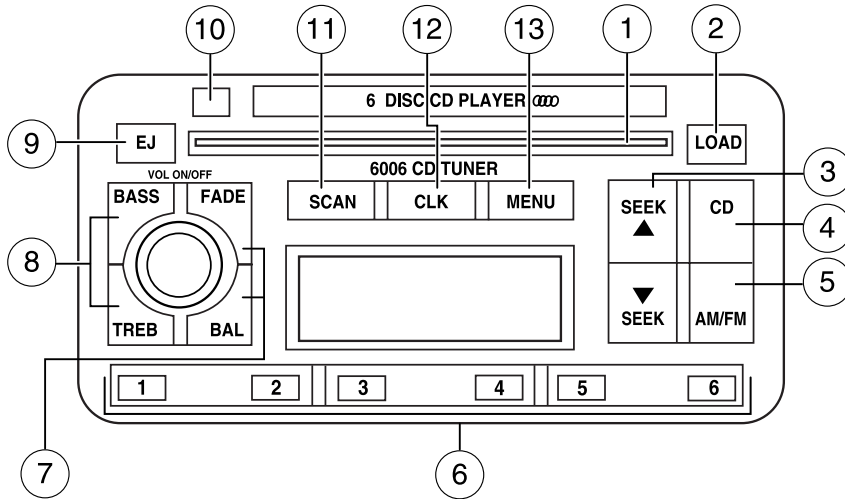

Entertainment Systems

9006 AM/FM SOUND SYSTEM WITH 6-DISC IN DASH CHANGER (IF EQUIPPED)

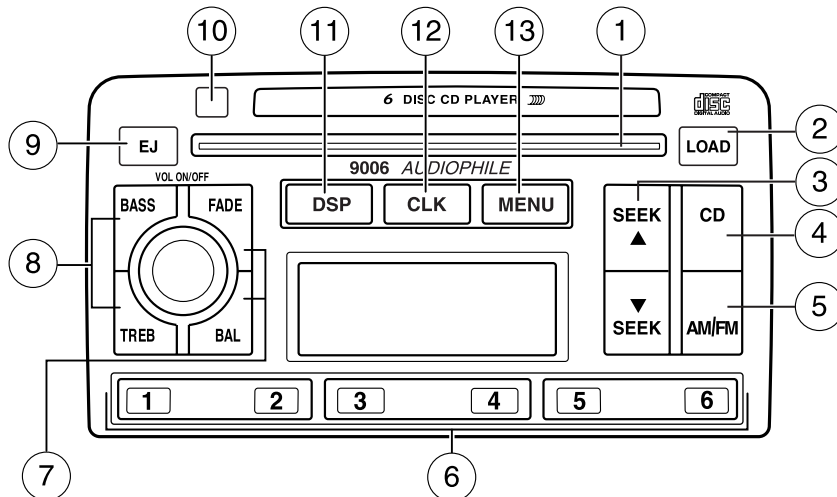

1. **CD Door:** Insert the disc with the playing side down and printed side up.



2. **Load:** Press to load a CD. WAIT will appear in the display then change to INSERT. Insert the CD. LOAD and a disc icon will flash in the display. Repeat this step to load up to 6 CDs.



3. **Seek** (reverse/fast forward): Press and release SEEK ▲ / ▼ for previous (reverse) / next (fast forward) strong station or CD track.



4. **CD:** Press to engage CD mode. CDs and tracks are selected and played chronologically. Disc one will follow disc six. Press the AM/FM control to restore radio reception without ejecting the disc.



Entertainment Systems

CD eject during playback: Press the eject control during CD playback to eject the CD. Press again to cancel the eject process. To eject another disc, press the preset control that corresponds to the desired disc then press EJ. EJECT CD will appear in the display. REMOVE will appear as the disc is held ready to be removed. If not removed, the audio system will the disc in again and playback will begin. INSERT is displayed briefly to allow a new disc to be inserted if desired.

5. **AM/FM:** Press to toggle between AM/FM1/FM2 frequency bands and or press to stop CD play.



6. **Memory presets:** To set a station: Select frequency band AM/FM; tune to a station, press and hold a preset button until sound returns. With a CD, press the preset control that corresponds to the desired disc. CD 1-01. CD 3-01, NO DISC or NO DISCS will be displayed depending on what preset button was selected.

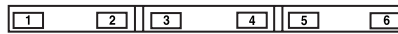

AutoStore: AutoStore allows you to set strong radio stations on the FM band without losing your original manually set preset stations. Press and hold AM/FM to activate. AST will flash in the display. When the six strongest stations are filled, the sound will be restored.

7. **Fade:** Press FADE; turn the volume control to shift sound to the rear/front speakers. The display will indicate the level selected.

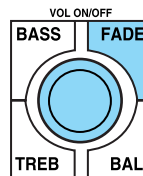

Balance: Press BAL; turn the volume control to shift sound to the left/right speakers. The display will indicate the level selected.

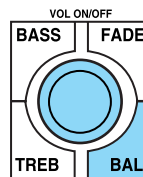

Entertainment Systems

8. **Bass:** Press BASS to adjust the bass levels. Turn the volume control to decrease/increase the bass output.

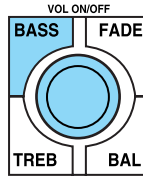

Treble: Press to adjust the treble levels. Turn the volume control to decrease/increase the treble output.

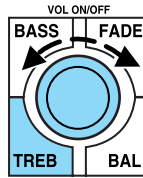

9. **Eject:** Press to eject a CD. Press and hold to eject all loaded discs.



10. **Anti-theft protection panel:** To deter would-be thieves, Ford audio units have a removable front panel without which the unit will not work.

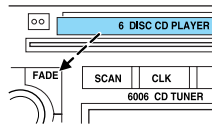

Avoid touching the contacts on the back of the panel and do not use excessive force to refit it.

Press the security release control and remove the front panel. To reposition the panel, insert the right-hand edge first, then the left-hand side, until the retaining latch is engaged.

Replacement panels: Your Ford Dealer will require the following if you need to order a replacement panel:

- Your name and address.
- The vehicle identification number (visible in the corner of the windscreen).
- The audio unit type.
- Proof of identification (i.e. driver's license).
- A vehicle invoice (if the audio unit was installed in the vehicle prior to delivery) or a parts invoice if the audio unit was purchased separately from the vehicle, or an appropriate vehicle registration document.

Entertainment Systems

11. **Scan:** Press SCAN to move up the radio frequency band. SCAN automatically finds a station, plays it for five seconds, then moves to the next station. Press again to stop.

SCAN

CD: Press SCAN to sample CD selections for eight seconds. Press again to stop.

DSP: Press once to enter occupancy mode and use the volume control to optimize sound for ALL seats, DRIVER or REAR. Press twice to select one of the settings: DSP OFF, NEWS, JAZZ, CONCERT, CHURCH or STADIUM.

12. **Clock:** Setting the clock – With the radio ON, press and hold CLK until the hour digit flashes. Turn the volume control to increase/decrease the hour. Press CLK again for the minutes and turn the volume control to increase/decrease the minutes. Press CLK again to return to normal operation.

CLK

Selecting 12 or 24 hour format: Press and hold MENU to reach the extended menu. Press MENU repeatedly until 12/24 HOUR is displayed. Press SEEK▲ / ▼ to toggle between 12 and 24 hour modes.

13. **Menu:** Press MENU to access main menu functions. Use SEEK ▲ / ▼ for adjustments.

MENU

Tune adjust: Press MENU until MAN appears in the display. Press ▲ or ▼ to manually move up/down the radio frequency band.

Compression: Press MENU until COMP appears in the display. Press SEEK to engage/disengage the feature. Compression adjust brings soft and loud CD passages together for a more consistent listening level.

Shuffle: Press MENU until SHUF appears in the display. Press SEEK to engage/disengage the feature.

Audio distortion reduction (CLIP): Press and hold MENU until the display changes. Then, press MENU until the CLIP menu displays. Press SEEK to engage/disengage the feature. The feature automatically detects sound distortions and reduces the volume level until the distortion has been eliminated.

Automatic volume control (AVC) (if equipped): With this feature, radio volume changes automatically with vehicle speed to compensate for road and wind noise. Press MENU until AVC is displayed, then use the SEEK ▲ / ▼ control to adjust the volume.

Entertainment Systems

IN-DASH CD/MP3 SOUND SYSTEM (IF EQUIPPED)

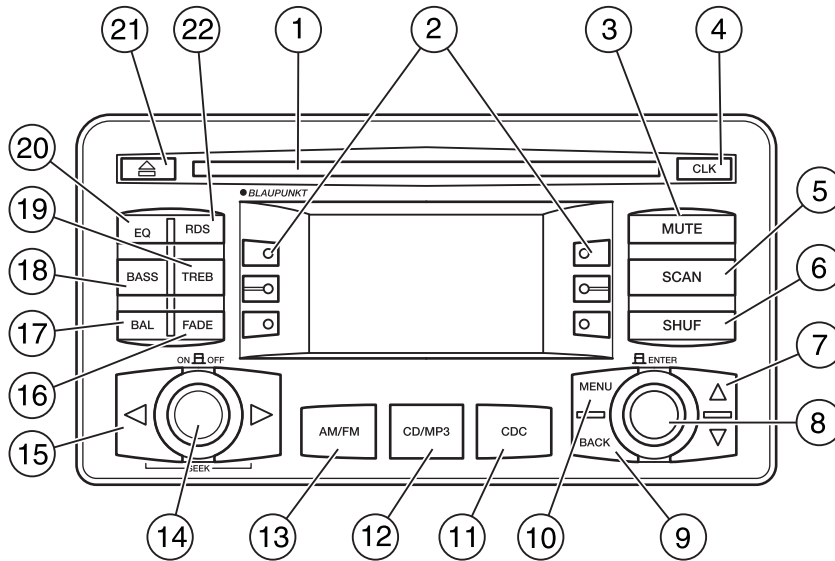

1. **CD door:** Insert a CD or MP3 label side up.

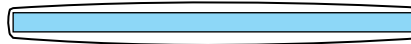

2. **Soft keys:** Press to make various selections in the audio menus.

3. **Mute:** Press to mute the playing media. Press again to return. (Turning the volume control will also disable the mute feature).



4. **Clock:** Press to alternate the display between clock and audio information.



5. **Scan: Radio and CD:** Press to hear a brief sampling of all radio stations or CD tracks. Press again to stop.



MP3: Press once for a brief sampling of the tracks on the currently selected MP3 directory. SCN ALB appears at the bottom of the display.

Entertainment Systems

SHF ALB appears in the display. Press again for a brief sampling of all MP3 directories on the disc. SCAN ALL appears at the bottom of the display.

6. **Shuffle: CD/CD changer:** Press to play the songs on the current CD in random order. SHUF ALB appears in the display.



MP3: Press once to shuffle the tracks in the current MP3 directory. Press again to shuffle the tracks in all the MP3 directories. SHUF ALL appears in the display.

7. Reverse / forward:

Radio / CD: In radio mode, press ▲ / ▼ to select the previous or next station in each band.

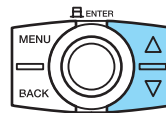

Press ▲ / ▼ for previous (reverse) / next (fast forward) CD track.

MP3: Press to select directories. Turn the right control knob to select the previous/next track. Press ▼ / ▲ to advance to the next/previous directory.

8. **Enter:** Turn to manually tune up or down the radio frequencies and select the tracks in either CD or MP3 mode.

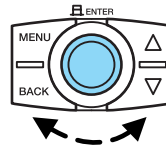

9. **Back:** Use in the various menus to go back to the previous screen/choice.



10. **Menu:** Press MENU to access main menu functions. Turn the right control knob to select a menu setting. There are five menu settings to select from: DISPLAY, VOLUME, CLOCK, AUDIO and DEFAULT RESET. Turn the right control knob to highlight the selection, then press ENTER for a sub-menu to appear. When complete, press BACK twice to reestablish the main menu. Press BACK three times, to leave the menu setting.



Entertainment Systems

Sharx: This function reduces the amount of interference from other radio stations in areas with a high density of stations. Select AUDIO and press ENTER. Select SHARX and press ENTER. Turn the control to turn the function on/off. Press ENTER to save the setting.

SETTINGS	
DISPLAY	
VOLUME	
CLOCK	
AUDIO	
DEFAULT RESET	

Program type (PTY): When selected, this function allows you to view the radio broadcast information (if any) or search for stations broadcasting a particular program type. Select AUDIO and press ENTER. Select PTY to view the broadcast information or PTY SEARCH to search for stations broadcasting a particular program type. There are 30 different possible program types, some being: News, Inform, Sports, Talk, Rock, Country, Jazz, etc. If no station is found broadcasting the selected program type, NO PTY will appear in the display at the end of the search.

Display/brightness: Adjusts the brightness level of the display. You may adjust the setting to: DAY/NIGHT, DIM DAY, DIM NIGHT or ANGLE.

Automatic volume control (AVC): Radio volume changes automatically with vehicle speed to compensate for road and wind noise. Select VOLUME and press ENTER. Select AVC, then press ENTER.

Status clock: When ON, the time is shown in the lower left hand corner of the display. Select CLOCK and press ENTER. Select STATUS CLOCK and press ENTER. Turn the control to turn the feature on/off. If the large clock display is ON, it will be automatically toggled to OFF. Pressing CLK will toggle between the two.

Main clock: When selected, the time appears in the display when the audio is off but the ignition is on. Select MAIN CLOCK and press ENTER. Turn the control to turn on/off. Press BACK to save the setting.

Set clock: To set the time, select CLOCK and press ENTER. Select SET CLOCK and press ENTER. Each press of the ENTER control will toggle between minutes and hours. Turn the control to increase/decrease the hours/minutes. Press BACK to exit the setting.

CLOCK	
STATUS CLOCK	ON
MAIN CLOCK	ON
SET CLOCK	
12:30 PM	

Note: The clock only operates in 12 hour mode. To change between AM and PM, cycle through the hours until the desired hour is reached.

Default reset: To reset all settings to their default values, select DEFAULT RESET and press ENTER. Turn the control to select yes or no. If yes is selected, the audio unit will return to all of its default settings.

Entertainment Systems

Traffic Announcements: When activated, the audio unit will automatically switch from the current playing media to a traffic announcement when received. When the announcement is over, the system will return to the current playing media. Select AUDIO and press ENTER. Select TRAF ANNOU and press ENTER. Turn the rotary control to turn on/off. Press BACK to save the setting. *Traffic announcements not available in most U.S. markets.*

Loudness: This function boosts the bass frequencies. Select VOLUME and press ENTER. Select LOUDNESS and press ENTER. Turn the control to increase/decrease the levels. Press BACK to save the setting.

11. **CDC:** Press to access the CD changer. Press the desired soft key to select from the CDs in the CD changer. During playback, press to repeat the current track. If there are no CDs in the CD changer, the display will read NO CHANGER.



12. **CD/MP3:** Press to play a CD/MP3 that is already loaded in the system. NO CD will appear in the display and a beep will sound if there are not any CDs loaded into the system.



Repeat track/repeat album: Press during CD or MP3 playback to repeat the current track or, in MP3 mode, the current album. Press the softkey next to RPT TRCK or RPT ALB. The track will continue repeating until you select RPT OFF.

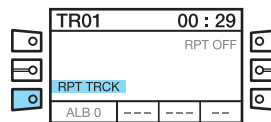

13. **AM/FM:** Press repeatedly to select from AM/FM1/FM2/FM3.



14. **On/off/volume:** Press to turn on/off. Turn to adjust the volume levels. The level will appear in the display. Press with the ignition off to use the audio for up to one hour.

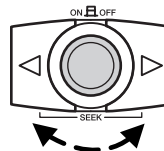

Entertainment Systems

15. **Seek:** In radio mode, press to locate radio stations up or down the frequency band.

To store a station, press and hold the soft key (next to the desired frequency) until you hear a beep.

This indicates the station has been stored. To select a station, press the soft key next to the desired frequency.

CD/MP3: Press to select the previous/next track of the current CD/MP3.

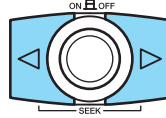

16. **Fade:** Press FADE and turn the right control knob (ENTER) to shift sound to the rear/front speakers. The display will indicate the level selected.



17. **Balance:** Press BAL then turn the right control knob (ENTER) to adjust the audio between the left and right speakers. The selected level will appear in the display.



18. **Bass:** Press to adjust the bass levels. Turn the right control knob (ENTER) to increase/decrease levels. The selected level will appear in the display.



19. **Treble:** Press to adjust the treble levels. Turn the right control knob (ENTER) to increase/decrease levels. The selected level will appear in the display.



20. **Eq:** Press to activate the equalizer. There are seven choices in this mode: EQ-OFF, ROCK, POP, DISCO, JAZZ, CLASICAL, and VOCAL.



21. **Eject:** Press to eject the CD/MP3.



22. **RDS (Radio Data System):**

The system is equipped with a decoder that receives special signals transmitted on the FM frequency. The station's name and information will show in the display. Press RDS repeatedly to turn the feature on/off. The preset locations will not save the RDS name only the frequency.



Entertainment Systems

MP3 INFORMATION

- When the system is playing an MP3 disc, the directory name, track name and artist name are shown in the display. The directory number also appears in the left hand corner of the display.
- A maximum of 20 directories is recommended as additional directories will increase the access time.
- Each directory can contain a maximum of 254 tracks and sub-directories.
- Avoid special characters when naming directories and files.
- MAIN will appear in the display when files are not stored in directories.
- CD-R media is supported, but CD-RW is not.
- If more than one session is written to the CD, only the first session will be detected.

TR01	00 : 29
DIRECTORY NAME	
TRACK NAME	
ARTIST NAME	
ALB 052	--- --- --

RADIO FREQUENCIES

AM and FM frequencies are established by the Federal Communications Commission (FCC) and the Canadian Radio and Telecommunications Commission (CRTC). Those frequencies are:

AM - 530, 540–1700, 1710 kHz

FM- 87.7, 87.9–107.7, 107.9 MHz

RADIO RECEPTION FACTORS

There are three factors that can affect radio reception:

- Distance/strength: The further you travel from an FM station, the weaker the signal and the weaker the reception.
- Terrain: Hills, mountains, tall buildings, power lines, electric fences, traffic lights and thunderstorms can interfere with your reception.
- Station overload: When you pass a broadcast tower, a stronger signal may overtake a weaker one and play while the weak station frequency is displayed.

CASSETTE/PLAYER CARE

Do:

- Use only cassettes that are 90 minutes long or less.

32

2004 Focus (foc)
Owners Guide (post-2002-fmt)
USA English (fus)

Entertainment Systems

- Tighten very loose tapes by inserting a finger or pencil into the hole and turning the hub.
- Remove loose labels before inserting tapes.
- Allow tapes which have been subjected to extreme heat, humidity or cold to reach a moderate temperature before playing.
- Clean the cassette player head with a cassette cleaning cartridge after 10–12 hours of play to maintain good sound/operation.

Don't:

- Expose tapes to direct sunlight, extreme humidity, heat or cold.
- Leave tapes in the cassette player for a long time when not being played.

CD/CD PLAYER CARE

Do:

- Handle discs by their edges only. Never touch the playing surface.
- Inspect discs before playing. Clean only with an approved CD cleaner and wipe from the center out.

Don't:

- Expose discs to direct sunlight or heat sources for extended periods of time.
- Insert more than one disc into each slot of the CD changer magazine.
- Clean using a circular motion.

CD units are designed to play commercially pressed 12 cm (4.75 in) audio compact discs only. Due to technical incompatibility, certain recordable and re-recordable compact discs may not function correctly when used in Ford CD players. Irregular shaped CDs, CDs with a scratch protection film attached, and CDs with homemade paper (adhesive) labels should not be inserted into the CD player. The label may peel and cause the CD to become jammed. It is recommended that homemade CDs be identified with permanent felt tip marker rather than adhesive labels. Ball point pens may damage CDs. Please contact your dealer for further information.

AUDIO SYSTEM WARRANTY AND SERVICE

Refer to the *Warranty Guide* for audio system warranty information. If service is necessary, see your dealer or qualified technician.

Climate Controls

HEATER ONLY SYSTEM (IF EQUIPPED)

1. **Air flow selections:** Controls the direction of the airflow in the cabin. See the following for a brief description on each control.

 : Distributes air through the instrument panel vents.



 : Distributes air through the instrument panel vents and the floor vents.

 : Distributes air through the floor vents.

 : Distributes air through the windshield defroster vents and floor vents.

 : Distributes air through the windshield defroster vents.

2. **Fan speed adjustment:** Controls the volume of air circulated in the cabin.

3. **Recirculated air:** Press to toggle between outside air and recirculated air. May help reduce undesirable odors from entering the vehicle. Recirculated air will not function in  or any position in between  and .

4. **Temperature selection:** Controls the temperature of the airflow in the cabin.

Operating tips

- To reduce fog build up on the windshield during humid weather, place the air flow selector in the  position and turn the fan to the highest setting.
- To reduce humidity build up inside the vehicle during cold or warm weather, do not drive with the air flow selector in the OFF position.
- Under normal weather conditions, do not leave the air flow selector in OFF when the vehicle is parked. This allows the vehicle to “breathe” using the outside air inlet vents.
- Do not put objects under the front seats that will interfere with the air flow to the back seats.
- Remove any snow, ice or leaves from the air intake area at the base of the windshield.

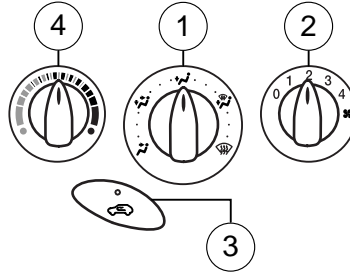

Climate Controls

To allow side window defogging and demisting while warming up the vehicle cabin:

1. Select .
2. Set the temperature control to full heat.
3. Set the fan speed to the highest setting.
4. Direct the outer instrument panel vents towards the side windows.

To increase airflow to the outer instrument panel vents, close the vents located in the middle of the instrument panel.



Do not place objects on top of the instrument panel as these objects may become projectiles in a collision or sudden stop.

MANUAL HEATING AND AIR CONDITIONING SYSTEM (IF EQUIPPED)

1. Air flow selections: Controls the direction of the airflow in the cabin. See the following for a brief description on each control.

 : Distributes air through the instrument panel vents.

 : Distributes air through the instrument panel vents and the floor vents.

 : Distributes air through the floor vents.

 : Distributes air through the windshield defroster and demister vents and floor vents.



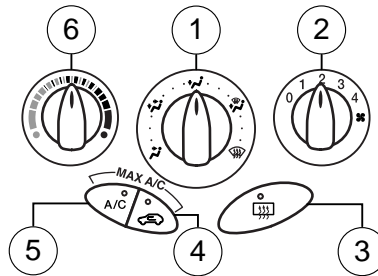

 : Distributes air through the windshield defroster and demister vents. This mode can be used to clear the windshield of thin ice and fog.

2. Fan speed adjustment: Controls the volume of air circulated in the cabin. **Note:** When the fan is turned to the O (OFF) position, the A/C is also turned off.

3. Rear Defrost (if equipped): Refer to *Rear window defroster* in this chapter.



Climate Controls

4.  **Recirculated air:** Press to activate/deactivate air recirculation in the vehicle cabin. Recirculated air may reduce the amount of time required to cool down the interior of the vehicle and may also help reduce undesired odors from reaching the interior of the vehicle. Recirculated air will not function in  or any position in between  and .

5. **A/C:** Provides cabin cooling.

6. **Temperature selection:** Controls the temperature of the airflow in the cabin.

Max A/C: For maximum cabin cooling performance, select A/C (5) and  (4).

Operating tips

- To reduce fog build up on the windshield during humid weather, place the air flow selector in the  position and turn the fan on.
- To reduce humidity build up inside the vehicle, do not drive with the fan turned off or with recirculated air engaged.
- Do not put objects under the front seats that will interfere with the airflow to the back seats.
- Remove any snow, ice or leaves from the air intake area at the base of the windshield.
- To improve A/C cool down, drive with the windows slightly open for 2–3 minutes after starting the vehicle or until the vehicle has been “aired out.”

To allow side window defogging and demisting while warming up the vehicle cabin:

1. Select .
2. Select A/C.
3. Set the temperature control to maintain comfort.
4. Set the highest fan speed.
5. Direct the outer instrument panel vents towards the side windows.

To increase airflow to the outer instrument panel vents, close the vents located in the middle of the instrument panel.



Do not place objects on top of the instrument panel as these objects may become projectiles in a collision or sudden stop.

Climate Controls

REAR WINDOW DEFROSTER

The rear defroster control is located on the instrument panel.

Press the rear defroster control to clear the rear window of thin ice and fog.

- A small LED will illuminate when the rear defroster is activated.

The ignition must be in the ON position to operate the rear window defroster.

The defroster turns off automatically after 14 minutes or when the ignition is turned to the OFF position. To manually turn off the defroster before 14 minutes have passed, push the control again.

Do not use razor blades or other sharp objects to clean the inside of the rear window or to remove decals from the inside of the rear window. This may cause damage to the heated grid lines and will not be covered by your warranty.

Lights

HEADLAMP CONTROL ☀

○ Turns the lamps off.

☀ Turns on the parking lamps, instrument panel lamps, license plate lamps and tail lamps.

☀ Turns the headlamps on.

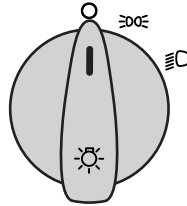

Foglamp control (if equipped) ⚡

The headlamp control also operates the foglamps. The foglamps can be turned on when the headlamp control is in the ☀ position and the high beams are not turned on.

Pull headlamp control towards you to turn foglamps on. The foglamp indicator light ⚡ will illuminate.

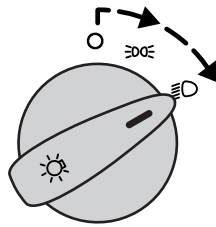

Daytime running lamps (DRL) (if equipped)

Turns the headlamps on with a reduced output.

To activate:

- the ignition must be in the ON position,
- the headlamp control is set to OFF or parking lamp position and
- the parking brake must be disengaged.



Always remember to turn on your headlamps at dusk or during inclement weather. The Daytime Running Lamp (DRL) system does not activate with your tail lamps and generally may not provide adequate lighting during these conditions. Failure to activate your headlamps under these conditions may result in a collision.

Lights

High beams

Push the lever toward the instrument panel to activate. Pull the lever towards you to deactivate.

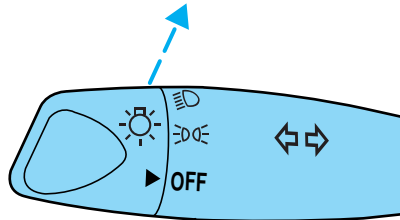

Flash to pass

Pull toward you slightly to activate and release to deactivate.

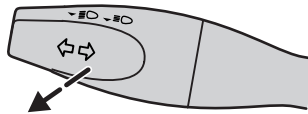

PANEL DIMMER CONTROL

Use to adjust the brightness of the instrument panel during headlight and parklamp operation.

- Rotate the thumbwheel from left to right to brighten the instrument panel.
- Rotate the thumbwheel from right to left to dim the instrument panel.

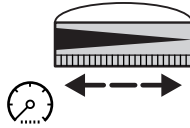

Domelamp Control

The panel dimmer control also controls the domelamp operation.

- Rotate the thumbwheel fully to the right to activate the domelamp.
- In order to turn off the domelamp, rotate the thumbwheel to the left.

Lights

VERTICAL AIM ADJUSTMENT

Your vehicle is fitted with either **VOR** (conventional halogen) or **VOL** (High Intensity Discharge - HID) headlamps. The adjustment procedure depends on the type of headlamps that are equipped on your vehicle. **VOR** is marked on the bottom inboard corner of the lens. **VOL** is marked on the top of the lens between the rubber seal and black plastic housing. Please check the lens markings prior to adjusting the vehicle aim.

VOR

1. Park the vehicle on a level surface directly in front of a vertical wall or screen, approximately 7.6 meters (25 feet) away.
2. Measure the height of the headlamp bulb center from the ground and mark a 2.5 meters (8 foot) horizontal reference line on the vertical wall or screen at this height. (A piece of masking tape works well.)
3. Turn on the low beam headlamps to illuminate the wall or screen and open the hood.
4. On the wall or screen you will observe an area of high intensity light. The top of the high intensity area should touch the horizontal reference line. If not, the beam will need to be adjusted.
5. Locate the vertical adjuster on each headlamp. Using a 7mm Allen wrench, turn the adjuster either clockwise (to adjust down) or counterclockwise (to adjust up). The high intensity area should touch the horizontal reference line.

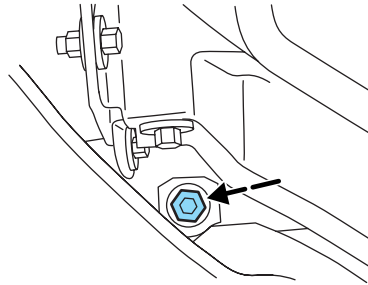

Note: HORIZONTAL AIM IS NOT REQUIRED FOR THIS VEHICLE AND IS NON-ADJUSTIBLE.

6. Close the hood and turn off the lamps.

VOL (HID)

1. Park the vehicle on a level surface approximately 7.6 meters (25 feet) from a vertical wall or screen directly in front of it.

2. Measure the height of the headlamp bulb center from the ground, subtract 53.3 mm (2.1 inches), and make 2.5 meters (8 foot) horizontal reference line on the vertical wall or screen at this height. (A piece of masking tape works well.)

3. Open the hood.

4. Remove the battery cover.

5. Remove the headlamp bulb cover by releasing the four snap hooks (two top and two bottom).

Note: On the left headlamp, pull the bulb cover approximately 1 inch rearward and then slide it out until the vertical aiming adjuster is accessible.

6. Turn on the low beam to illuminate the wall or screen. On the wall or screen you will observe an area of high intensity light. If the left side of each light pattern is not at the reference line, the beam needs to be adjusted.

7. The adjusting screw has a thumb wheel that can be operated by hand. Turn the aiming screw clockwise for upward movement and counterclockwise for downward movement.

Note: HORIZONTAL AIMING IS NOT REQUIRED FOR THIS VEHICLE AND IS NON-ADJUSTABLE.

8. Turn off the headlamp.

9. Attach the headlamp bulb covers.

10. Attach the battery cover and close the hood.

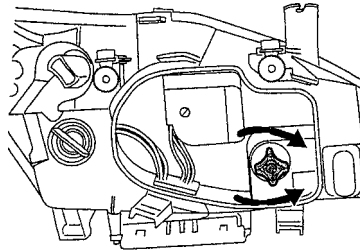
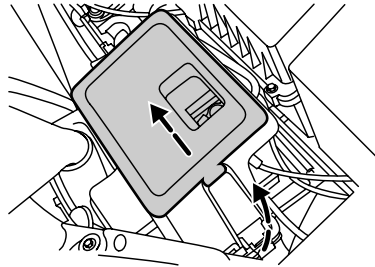

Lights

TURN SIGNAL CONTROL ⇐⇒

- Push down to activate the left turn signal.
- Push up to activate the right turn signal.

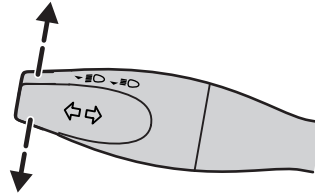

INTERIOR LAMPS

Dome lamps

The dome lamp is equipped with a control switch that will illuminate when:

- the doors are closed and the switch is in the on position.
- the switch is in the door activated position and any door is open.

When the dome lamp switch is in the off position, it will not illuminate when you open the doors.

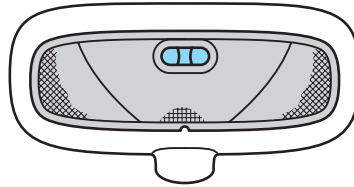

Reading lamps (if equipped)

The reading lamps are operated by separate on/off controls.

Theater dimming: The dome lamp dims about 20 seconds after the doors are closed.

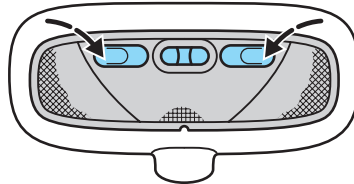

Lights

BULBS

Replacing exterior bulbs

Check the operation of all the bulbs frequently.

Using the right bulbs

Replacement bulbs are specified in the chart below. Headlamp bulbs must be marked with an authorized "D.O.T." for North America to assure lamp performance, light brightness and pattern and safe visibility. The correct bulbs will not damage the lamp assembly or void the lamp assembly warranty and will provide quality bulb burn time.

Function	Trade number
Headlamps (VOR)	HB2
Headlamps (high beam, VOL)	H7
Headlamps (low beam, VOL)	D2S
Park lamp (front, VOL)	W5W
Turn lamp (front, VOL)	3457K
Park and turn lamp (front)	3157K
Side marker lamp (front)	GE194
Foglamps (if equipped)	899
Stop/turn and tail lamps	3157K
Backup lamp (sedan/wagon)	3156K
Backup lamp (coupe)	921
License plate lamp	C-5W
High-mount brakelamp	W5W
Dome lamp (front/rear)	12V10W
Map lamp	12V6W
Luggage compartment	12V10W
To replace all instrument panel lights - see your dealer	

Replacing the interior bulbs

Check the operation of the bulbs frequently. To replace any of the interior bulbs, see a dealer or qualified technician.

Lights

Replacing headlamp bulbs

Make sure the headlamp switch is in the OFF position.

To remove the high or low beam headlamp bulb:

1. Lift the hood and remove the bulb cover.
2. Swivel the wire clip to the side and pull out the lamp.
3. Pull the bulb holder straight out from the lamp assembly.
4. Pull the bulb straight out from the bulb holder.

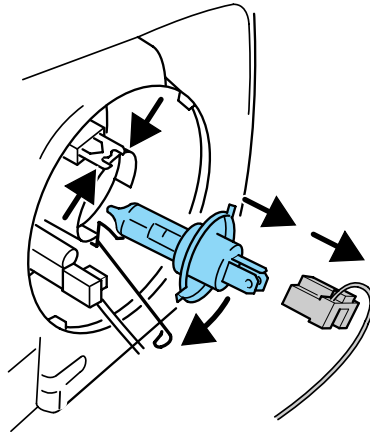

Install in reverse order.



Handle a halogen headlamp bulb carefully and keep out of children's reach. Grasp the bulb by only its plastic base and do not touch the glass. The oil from your hand could cause the bulb to break the next time the headlamps are operated.

Note: If the bulb is accidentally touched, it should be cleaned with rubbing alcohol before being used.

Replacing HID headlamp bulbs (if equipped)

The low beam headlamps on your vehicle use a “high intensity discharge” source. These lamps operate at a high voltage. When the bulb is burned out, the bulb and starter capsule assembly must be replaced by your dealer or a qualified technician.

Replacing grill-mounted front parking lamp/turn signal bulbs

1. Make sure the headlamp control is in the OFF position and open the hood.
2. Remove the cover panel at the front of the engine compartment.
3. Remove the bulb socket from the grille by turning counterclockwise.
4. Pull the bulb straight out of the socket.

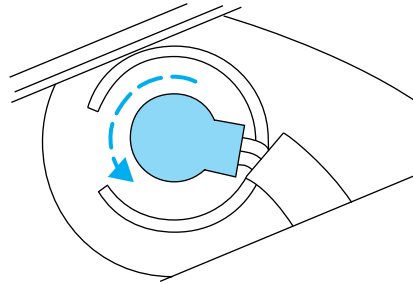

Install in reverse order.

Replacing turn signal lamps

1. Make sure the headlamp control is in the OFF position.
2. Open the hood and remove the bulb socket from the headlamp unit by turning it counterclockwise.
3. Pull the bulb straight out of the bulb socket.

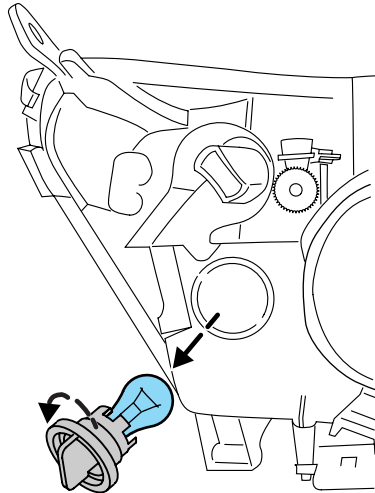

Note: On vehicles fitted with VOL (HID) headlamps, have your Ford dealer change the park lamp bulbs.

Lights

Replacing tail/brake/backup lights and turn signal bulbs (coupe)

1. Make sure the headlamp control is in the OFF position and then open the hatchback.

2. From inside the luggage compartment remove the wing nut of the rear light assembly cover.

3. Using a Phillips screwdriver remove the screw. The lamp is still retained by a spring loaded clip. Remove by gently pulling out the light housing.

4. Turn the bulb socket counterclockwise as far as possible and pull it out.

5. Pull the bulb straight out of the socket.

Install in reverse order.

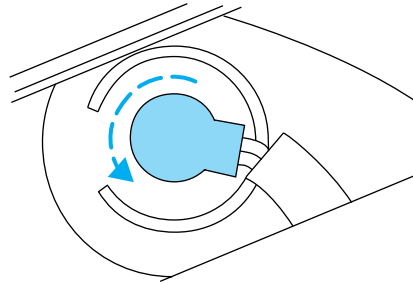

Replacing tail/brake/backup lights and turn signal bulbs (sedan)

1. Make sure the headlamp control is in the OFF position and then open the trunk.

2. From inside the luggage compartment remove the three wing nuts of the light housing.

3. Gently pull the light housing to the outside.

4. Turn the bulb socket counterclockwise and pull it out.

5. Pull the bulb straight out of the socket.

Install in reverse order.

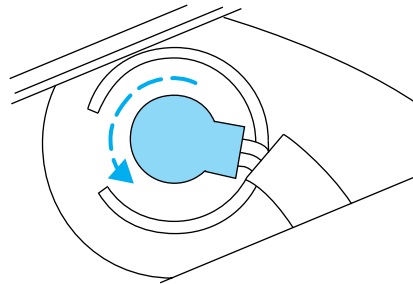

Lights

Replacing tail/brake/backup lights and turn signal bulbs (wagon)

1. Make sure the headlamp control is in the OFF position and then open the hatchback.
2. Using a screwdriver remove the fixings and trim from the body.
3. Remove the socket from the lamp assembly
4. Pull the bulb straight out of the socket.

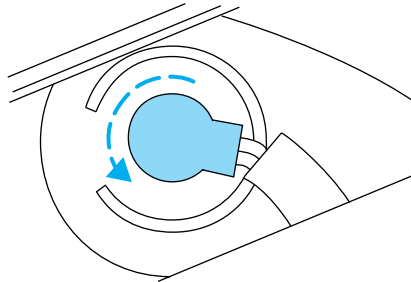

Install in reverse order.

Replacing foglamp bulbs (if equipped)

1. Make sure the headlamp control is in the OFF position.
2. Reach under the bumper cover and remove the bulb socket from the foglamp by turning counterclockwise.
3. Disconnect the electrical connector from the foglamp bulb.

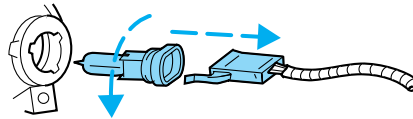

Install in reverse order.

Replacing side marker bulbs

1. Make sure the headlamp control is in the OFF position.
2. Reach under the front fender and grasp the bulb socket, turn the light housing counterclockwise.
3. Pull the bulb straight out.

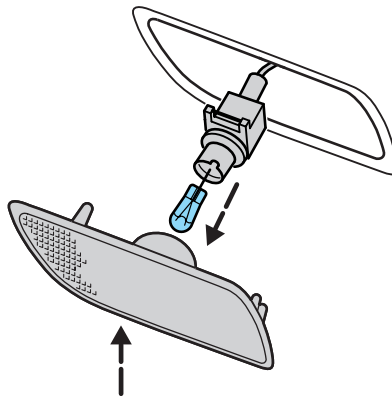

Install in reverse order.

Lights

Replacing high-mount brake lamp bulbs

Sedan

1. Make sure the headlamp control is in the OFF position and open the luggage compartment.
2. Using a screwdriver remove the trim from the tailgate.
3. Pull the bulb holder from the lamp assembly.
4. Pull the bulb straight out.

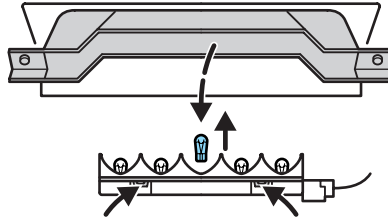

Install in reverse order.

Coupe and wagon

1. Make sure the headlamp control is in the OFF position.
2. Remove the screws using a torx T20 screwdriver and then remove the plastic cover.
3. Unclip the bulb holder from the reflector.
4. Pull the bulb straight out.

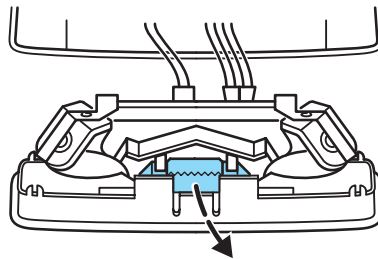

Install in reverse order.

Replacing license plate lamp bulbs

1. Make sure the headlamp control is in the OFF position.
2. Insert a flathead screwdriver in the recess and pry out the complete light assembly.
3. Pull the bulb straight out.

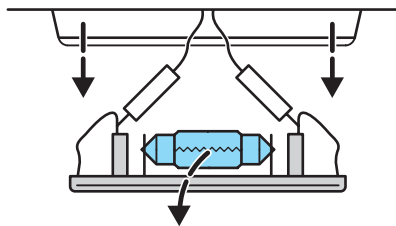

Install in reverse order.

Lights

Replacing the luggage compartment lamp

1. Make sure the headlamp control is in the OFF position.
2. Carefully pry out the light assembly from the holder with a flathead screwdriver.
3. Pull the bulb straight out.

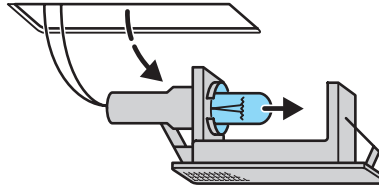

Install in reverse order.

Replacing interior lamps

1. Make sure the headlamp switch is in the OFF position.
2. Switch off the interior lamps (middle switch position).
3. Pry out the light assembly with a flat screwdriver at the side opposite the switch.

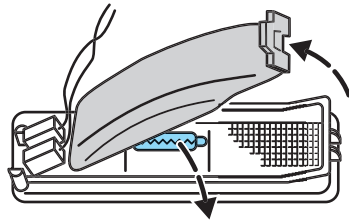

Install in reverse order

Replacing reading bulbs

1. Open the reading lamp assembly.
2. Pull the bulb straight out and replace it.
3. After the bulb has been replaced, close the lamp assembly.

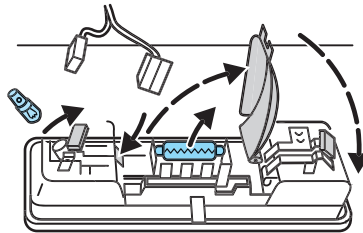

Install in reverse order.

Driver Controls

MULTI-FUNCTION LEVER

Windshield wiper: Move the lever down for a single wipe.

For intermittent operation, move control up one position and adjust the rotary control to the desired speed.

For normal operation, move control up two positions.

For high speed operation, move control up three positions.

Mist function: To mist, push and release the windshield washer control quickly. The wipers will cycle two or three times to clear the windshield.

Windshield washer: To activate the windshield washer, push the windshield washer control. Release control to stop washer fluid spray. The wipers will provide three wipes after the wash is turned off.

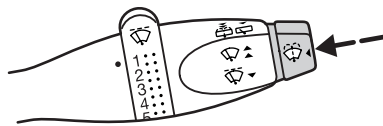
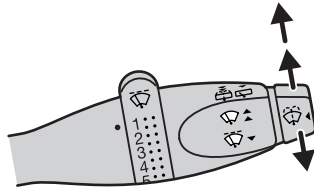

Rear window wiper/washer (if equipped)

Wiper

Pull the lever towards you for intermittent wiping.

Washer

Pull the lever further to operate the washer.

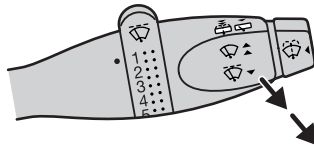

Driver Controls

Changing the wiper blades

1. Pull the wiper arm away from the vehicle. Turn the blade at an angle from the wiper arm. Push the lock pin manually to release the blade and pull the wiper blade down toward the windshield to remove it from the arm.

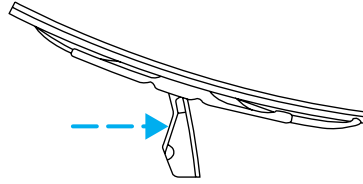

2. Attach the new wiper to the wiper arm and press it into place until a click is heard.

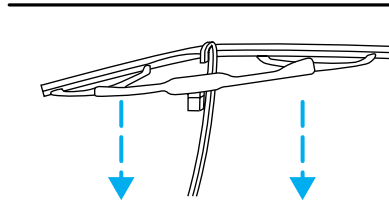

3. Replace wiper blades every 6 months for optimum performance.

TILT AND TELESCOPE STEERING COLUMN (IF EQUIPPED)

Pull the locking lever down to adjust and telescope the steering column position. Return the lever to its original position to secure the wheel.

The telescope function is adjusted by moving the wheel toward the driver to telescope out and toward the instrument panel to telescope in. Always place both hands opposite each other to adjust.

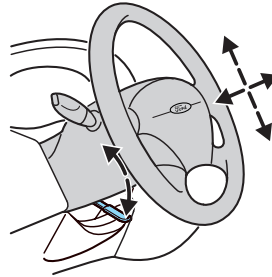

Never adjust the steering wheel when the vehicle is moving.

Driver Controls

HORN

Press the steering wheel pad. The horn can be operated when the ignition is off.

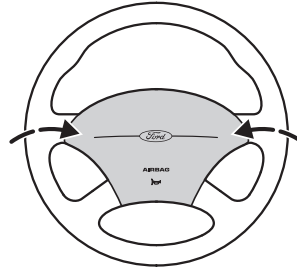

AUXILIARY POWER POINT (IF EQUIPPED)

Power point outlets are designed for accessory use only. Do not hang any type of accessories or accessory bracket from their plugs. Improper use of the power point outlet can cause damage not covered by your warranty.

Do not plug electrical accessories into the cigarette lighter socket (if equipped). Always use the power point.

Do not use the power point for operating the cigarette lighter element. The Maximum power each power point can supply depends on the fuse rating. For example: a 20A fuse should supply a maximum of 240 Watts, a 15A fuse should supply a maximum of 180 Watts. Exceeding these limits will result in a blown fuse.

Always keep the power point caps closed when not being used.

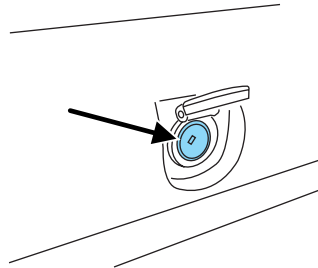

Driver Controls

POWER WINDOWS (IF EQUIPPED)



When closing the power windows, you should verify they are free of obstructions and ensure that children and/or pets are not in the proximity of the window openings.

Press and hold the bottom part of the rocker switch to open the window. Press and hold the top part of the rocker switch to close the window.

One touch down: Allows the driver's window to open fully without holding the control down.

Press the driver window control completely down then release. Press again to stop.

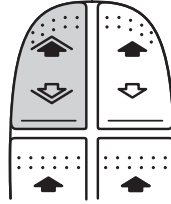

Window lock

The window lock feature allows only the driver to operate the power windows.

To lock out all the rear window controls slide the control to the left. Slide the control to the right to restore the window controls.

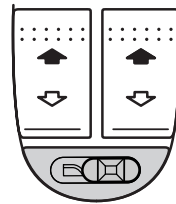

MIRRORS

Power side view mirrors

To adjust your mirrors:

1. Rotate the control clockwise to adjust the right mirror and rotate the control counterclockwise to adjust the left mirror.
2. Move the control in the direction you wish to tilt the mirror.
3. Return to the center position to lock mirrors in place.

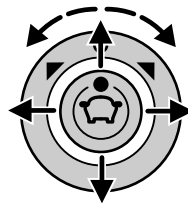

Driver Controls

Heated mirrors (if equipped)

Both mirrors are heated automatically to remove ice, mist and fog when the rear window defrost is activated.

Do not remove ice from the mirrors with a scraper or attempt to readjust the mirror glass if it is frozen in place. These actions could cause damage to the glass and mirrors.

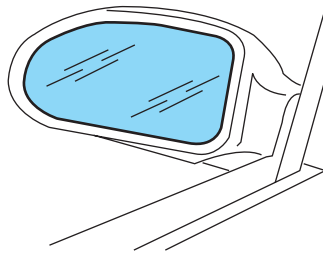

SPEED CONTROL (IF EQUIPPED)

With speed control set, you can maintain a speed of 48 km/h (30 mph) or more without keeping your foot on the accelerator pedal. Speed control does not work at speeds below 48 km/h (30 mph).



Do not use the speed control in heavy traffic or on roads that are winding, slippery or unpaved.

Setting speed control

The controls for using your speed control are located on the steering wheel for your convenience.

1. Press the ON control and release it.
2. Accelerate to the desired speed.

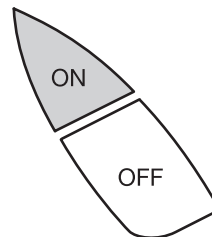

Driver Controls

3. Press the SET ACCEL control and release it.
4. Take your foot off the accelerator pedal.
5. The indicator light on the instrument cluster will turn on.

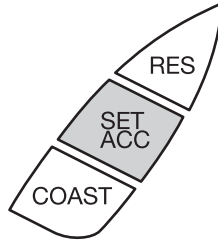

Note:

- Vehicle speed may vary momentarily when driving up and down a steep hill.
- If the vehicle speed increases above the set speed on a downhill, you may want to apply the brakes to reduce the speed.
- If the vehicle speed decreases more than 16 km/h (10 mph) below your set speed on an uphill, your speed control will disengage.

Disengaging speed control

To disengage the speed control:

- Depress the brake pedal or
- Depress the clutch pedal (if equipped).

Disengaging the speed control will not erase previous set speed.

Resuming a set speed

Press the RES (resume) control and release it. This will automatically return the vehicle to the previously set speed. The RES control will not work if the vehicle speed is not faster than 48 km/h (30 mph).

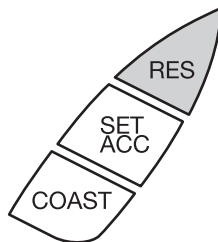

Driver Controls

Increasing speed while using speed control

There are two ways to set a higher speed:

- Press and hold the SET ACCEL control until you get to the desired speed, then release the control. You can also use the SET ACCEL control to operate the Tap-Up function. Press and release this control to increase the vehicle set speed in small amounts by 1.6 km/h (1 mph).
- Use the accelerator pedal to get to the desired speed. When the vehicle reaches that speed, press and release the SET ACCEL control.

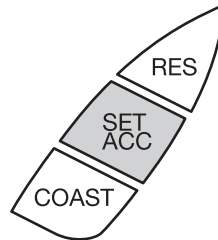

Reducing speed while using speed control

There are two ways to reduce a set speed:

- Press and hold the COAST control until you get to the desired speed, then release the control. You can also use the COAST control to operate the Tap-Down function. Press and release this control to decrease the vehicle set speed in small amounts by 1.6 km/h (1 mph).
- Depress the brake pedal until the desired vehicle speed is reached, press the SET ACCEL control.

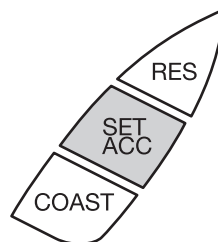
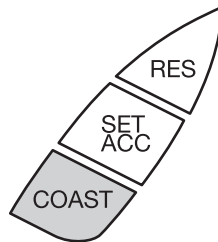

Driver Controls

Turning off speed control

Press the speed control OFF control.

Note: When you turn off the speed control or the ignition, your speed control set speed memory is erased.

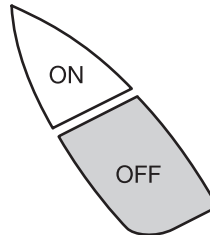

MOON ROOF (SUNROOF) (IF EQUIPPED)

You can move the glass panel of the moon roof back to open or tilt up to ventilate the vehicle.

To open the moon roof:

- Press and release the ▲ portion of the moon roof control to open.
- Press and hold (as desired) the ▼ portion of the moon roof control to close.
- To halt motion at any point during one-touch opening, press the control a second time.

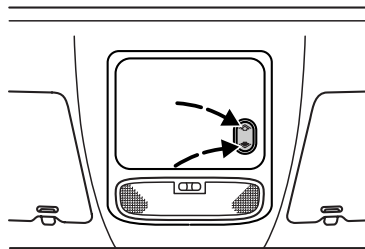

To vent:

- To tilt the moon roof into the vent position (when the glass panel is closed), press and hold the front portion of the control.
- To close the moon roof from the vent position, press and hold the rear portion of the control until the glass panel stops moving.

 Before operating the moonroof you should verify that it is free of obstructions and ensure that children and/or pets are not in the proximity of moon roof opening.

 Do not let children play with the moon roof. They may seriously hurt themselves.

Driver Controls

Relearning function: In case the moon roof does not close properly anymore, follow this relearning procedure.

- Tilt the moon roof into the vent position as far as possible. Release the switch.
- Press and hold the same switch again for 30 seconds until you see the moon roof move.
- Release the switch and immediately press and hold it again. The moon roof will close, open fully and then close again. Do not release the switch before the moon roof has reached the closed position for the second time.

Safety mode: If the system detects a malfunction, it enters a safety mode. The moon roof will move about 0.5 seconds at a time and then stop again. Press the switch repeatedly until the moon roof is closed. Have the system checked by your Ford Dealer immediately.

REMOTE LUGGAGE COMPARTMENT RELEASE (IF EQUIPPED)

To open the luggage compartment, press the control.

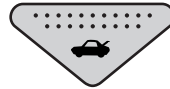

The control does not function if the vehicle is traveling faster than 7 km/h (4 mph).

ASHTRAY (IF EQUIPPED)

Pull to open.

To empty, push the cover completely down and firmly extract the ashtray.

Note: If the storage area is felt lined, it's a storage bin only, do not use as an ashtray. (Smokers package kit is available through Ford Accessories.)

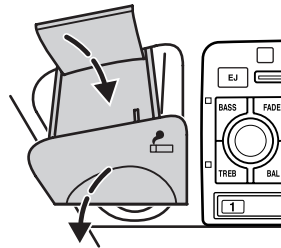

CELL PHONE USE

The use of Mobile Communications Equipment has become increasingly important in the conduct of business and personal affairs. However, drivers must not compromise their own or others' safety when using such equipment. Mobile Communications can enhance personal safety

Driver Controls

and security when appropriately used, particularly in emergency situations. Safety must be paramount when using mobile communications equipment to avoid negating these benefits.

Mobile Communication Equipment includes, but is not limited to cellular phones, pagers, portable email devices, in vehicle communications systems, telematics devices and portable two-way radios.



A driver's first responsibility is the safe operation of the vehicle. The most important thing you can do to prevent a crash is to avoid distractions and pay attention to the road. Wait until it is safe to operate Mobile Communications Equipment.

POSITIVE RETENTION FLOOR MAT

Position the driver floor mat so that the eyelet is over the pointed end of the retention post and rotate forward to lock in. Make sure that the mat does not interfere with the operation of the accelerator, brake pedal or clutch pedal (if equipped). To remove the floor mat, reverse the installation procedure.

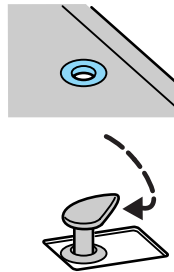

LUGGAGE COVER

Models with rear hatch

Detach the lifting straps on the liftgate. Release the cover at the sides and pull it out horizontally without tilting it.

Install in reverse order. Make sure the cover is properly aligned when inserting it.

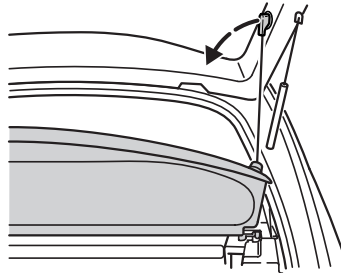



Driver Controls

Wagon

Pull out the roller cover and secure the retaining points. The cover can be removed completely by pressing inward on both ends of the support.

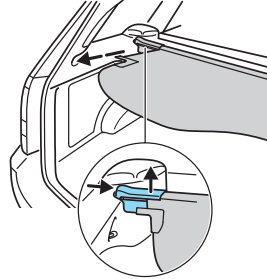
 To reduce the risk of injury, the luggage cover must be properly attached to the mounting clips.



 Do not place any objects on the cargo area cover. They may obstruct your vision or strike occupants of the vehicle in the case of a sudden stop or collision.

 The cover may cause injury in a sudden stop or accident if it is not securely installed.

LIFTGATE (WAGON ONLY)

You can open and close the liftgate from outside of the vehicle.

- To open the liftgate, unlock the wagon (with the power door locks or the remote entry key fob) and push the button next to the license plate.
- To close the liftgate, grab the pull handle (if equipped) and pull the liftgate down. If the tailgate doesn't close due to a load, do not use the pull handle to tie the liftgate down.
- To lock the liftgate, press the lock button down on the inside of the liftgate. Use the power door locks, or the remote entry key fob to lock the wagon.

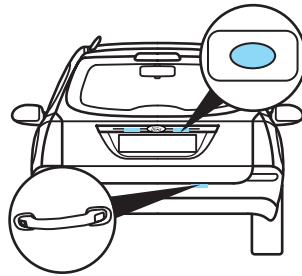

Driver Controls

Do not leave the liftgate open while driving. Doing so could cause serious damage to the liftgate and its components as well as allowing carbon monoxide to enter the vehicle.

 Make sure that the liftgate door is closed to prevent exhaust fumes from being drawn into the vehicle. This will also prevent passengers and cargo from falling out. If you must drive with the liftgate door open, keep the vents open so outside air comes into the vehicle.

LUGGAGE RACK (IF EQUIPPED)

The maximum recommended load is 100 kg (220 lbs) on the luggage rack structure. The load **must be** placed directly on the dealer installed cross bars (if equipped) and luggage rack. The vehicle's roof panel **is not** designed to carry a load.

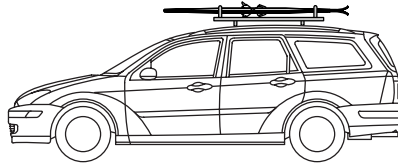

When loading the luggage rack, it is recommended to evenly distribute the load, as well as maintain a low center of gravity. Ensure that the load is securely fastened.

Your fuel economy will decrease when you drive with items on the luggage rack. When the rack is loaded, check the tightness of the rear adjusting thumbwheel before driving and at each refueling stop.

 Loaded vehicles, with a higher center of gravity, may handle differently than unloaded vehicles. Extra precautions, such as slower speeds and increased stopping distance, should be taken when driving a heavily loaded vehicle.

Locks and Security



KEYS

The key operates all locks on your vehicle. In case of loss, replacement keys are available from your dealer.

You should always carry a second key with you in a safe place in case you require it in an emergency.

POWER DOOR LOCKS

The power door lock controls are located on the driver and front passenger door panels.

Pressing the  will unlock all the doors. Pressing the  will lock all the doors.

The power door lock controls are disabled 20 seconds after the ignition is turned to the 2 (OFF) position.

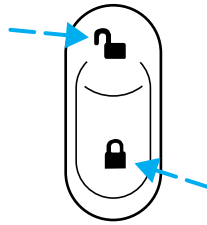

Autolock (if equipped)

The autolock feature will lock the vehicle's doors when:

- all the doors are closed,
- the ignition is in the 3 (ON) or 4 (START) position,
- you shift into forward or reverse, and
- you release the brake pedal, and
- the vehicle speed is greater than 4 mph (7 km/h).

Relock

The autolock feature repeats when:

- any door is opened then closed while the ignition is in the 3 (ON) position, and
- you shift into forward or reverse, and
- you release the brake pedal, and
- the vehicle speed is greater than 4 mph (7 km/h).

Locks and Security

To deactivate/reactivate the autolock feature using the power door unlock control

You must complete steps 1-7 within 30 seconds or the procedure will have to be repeated. If the procedure needs to be repeated, you must wait 30 seconds.

1. Turn the ignition to the 3 (ON) position.
2. Press the power door unlock control three times.
3. Turn the ignition from 3 (ON) position to the 2 (OFF) position.
4. Press the power door unlock control three times.
5. Turn the ignition back to 3 (ON) position. The horn will chirp.
6. Press the unlock control, then press the lock control. The horn will chirp once if autolock was deactivated or twice (one short and one long chirp) if autolock was activated.
7. Turn the ignition to the 2 (OFF) position. The horn will chirp once to confirm the procedure is complete.

Childproof door locks

- When these locks are set, the rear doors cannot be opened from the inside.
- The rear doors can be opened from the outside when the doors are unlocked.

The childproof locks are located on rear edge of each rear door and must be set separately for each door. Setting the lock for one door will not automatically set the lock for both doors.

- Insert the key and turn to the lock position (key vertical) to engage the childproof locks.
- Insert the key and turn to the unlock position (key horizontal) to disengage the childproof locks.

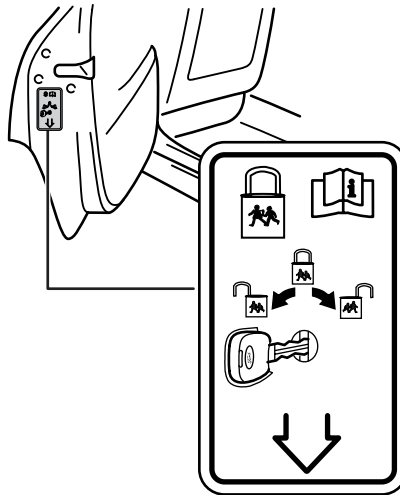

Locks and Security

INTERIOR LUGGAGE COMPARTMENT RELEASE

Your vehicle is equipped with a mechanical interior luggage compartment release handle that provides a means of escape for children and adults in the event they become locked inside the luggage compartment.

Adults are advised to familiarize themselves with the operation and location of the release handle.

To open the luggage compartment door (lid) from within the luggage compartment, pull the illuminated “T” shaped handle and push up on the trunk lid. The handle is composed of a material that will glow for hours in darkness following brief exposure to ambient light.

The “T” shaped handle will be located either on the luggage compartment door (lid) or inside the luggage compartment near the tail lamps.



Keep vehicle doors and luggage compartment locked and keep keys and remote transmitters out of a child's reach. Unsupervised children could lock themselves in the trunk and risk injury. Children should be taught not to play in vehicles.

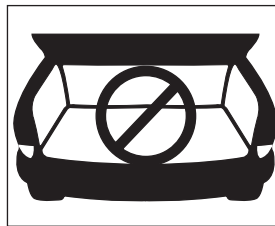

On hot days, the temperature in the trunk or vehicle interior can rise very quickly. Exposure of people or animals to these high temperatures for even a short time can cause death or serious heat-related injuries, including brain damage. Small children are particularly at risk.

Locks and Security

REMOTE ENTRY SYSTEM (IF EQUIPPED)

This device complies with part 15 of the FCC rules and with RS-210 of Industry Canada. Operation is subject to the following two conditions: (1) This device may not cause harmful interference, and (2) This device must accept any interference received, including interference that may cause undesired operation.

Changes or modifications not expressly approved by the party responsible for compliance could void the user's authority to operate the equipment.

The typical operating range for your remote entry transmitter is approximately 10 meters (33 feet). A decrease in operating range could be caused by:

- weather conditions,
- nearby radio towers,
- structures around the vehicle, or
- other vehicles parked next to your vehicle.

Your vehicle may have an all-door remote entry system.

The all-door remote entry system allows you to:

- lock or unlock all vehicle doors without a key.
- arm and disarm the anti-theft system. For more information on the anti-theft system, refer to *Perimeter alarm system (if equipped)* in this chapter.
- open the luggage compartment without a key.
- activate the panic alarm.

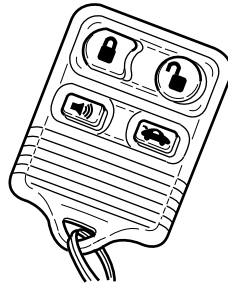



The remote entry features only operate with the ignition in the 1 (LOCK) or 2 (OFF) position.

If there is any potential remote keyless entry problem with your vehicle, ensure **ALL remote entry transmitters** are brought to the dealership, to aid in troubleshooting.



Locks and Security

Unlocking the doors

1. Press  and release to unlock the driver's door. **Note:** The interior lamps will illuminate.
2. With the all-door remote entry, press  and release again within three seconds to unlock all the doors.

The remote entry system activates the illuminated entry feature. This feature turns on the interior lamps for 25 seconds or until the ignition is turned to the 3 (ON) position. The dome lamp control must be set to the **ON** position in order for the illuminated entry feature to operate.

Locking the doors

- Press  and release to lock all doors. **Note:** The park/turn lamps will flash once.
- Press  and release a second time to confirm all doors. **Note:** The horn will make two quick chirps.

This process will also arm the vehicle's anti-theft system (if equipped). For more information on arming the anti-theft system, refer to *Perimeter alarm system (if equipped)* in this chapter.

Opening the luggage compartment

Press  once to open the luggage compartment. **Note:** This feature will only operate with the ignition in the 1 (LOCK) or the 2 (OFF) position.

- Ensure that the trunk is closed and latched before driving your vehicle. Failure to properly latch the trunk may cause objects to fall out or block the driver's rear view.

Sounding a panic alarm

Press  to activate the alarm. Press again or turn the ignition to 1 (ACCESSORY) or 4 (ON) to deactivate.

Note: The panic alarm will only operate when the ignition is in the 3 (OFF) position.

Locks and Security

Replacing the battery

The remote entry transmitter uses one coin type three-volt lithium battery CR2032 or equivalent.

To replace the battery:

1. Twist a thin coin between the two halves of the remote entry transmitter near the key ring. **DO NOT TAKE THE RUBBER COVER AND CIRCUIT BOARD OFF THE FRONT HOUSING OF THE REMOTE ENTRY TRANSMITTER.**

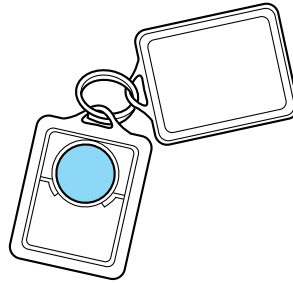

2. Do not wipe off any grease on the battery terminals on the back surface of the circuit board.

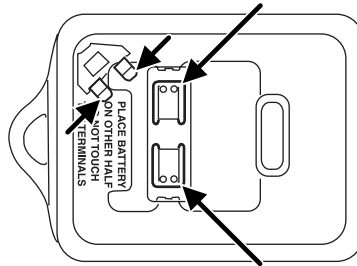

3. Remove the old battery.

4. Insert the new battery. Refer to the diagram inside the remote entry transmitter for the correct orientation of the battery. Press the battery down to ensure that the battery is fully seated in the battery housing cavity.

5. Snap the two halves back together.

Note: Replacement of the battery will **not** cause the remote transmitter to become deprogrammed from your vehicle. The remote transmitter should operate normally after battery replacement.

Replacing lost remote entry transmitters

If you would like to have your remote entry transmitter reprogrammed because you lost one, or would like to buy additional remote entry transmitters, you can either reprogram them yourself, or take **all remote entry transmitters** to your authorized dealer for reprogramming.

Locks and Security

How to reprogram your remote entry transmitters

You must have **all remote entry transmitters** (maximum of four) available before beginning this procedure.

To reprogram the remote entry transmitters:

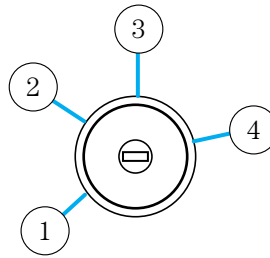

1. Close all doors and fasten the driver's seat belt to ensure conflicting chimes do not sound during the procedure.
2. Put the key in the ignition.
3. Turn the key from the 2 (OFF) position to the 3 (ON) position.
4. Cycle four times rapidly (within six seconds) between the 2 (OFF) and the 3 (ON) position. **Note:** The fourth turn must end in the 2 (OFF) position.
5. Within 20 seconds press any button on the remote entry transmitter. **Note:** If more than 20 seconds have passed you will need to start the procedure over again.
6. Repeat Step 5 to program each additional remote entry transmitter.
7. Turn the ignition to the 2 (OFF) position after you have finished programming all of the remote entry transmitters.

SECURILOCK™ PASSIVE ANTI-THEFT SYSTEM

SecuriLock™ passive anti-theft system is an engine immobilization system. This system is designed to prevent the engine from being started unless a **coded key programmed to your vehicle** is used. The use of the wrong type of coded key may lead to a “no-start” condition.

Your vehicle comes with two coded keys; additional coded keys may be purchased from your dealer. The dealer can program your spare keys to your vehicle or you can program the keys yourself. Refer to *Programming spare keys* for instructions on how to program the coded key.

Note: The SecuriLock™ passive anti-theft system is not compatible with non-Ford aftermarket remote start systems. Use of these systems may result in vehicle starting problems and a loss of security protection.

Locks and Security

Note: Large metallic objects, electronic devices that are used to purchase gasoline or similar items, or a second coded key on the same key chain may cause vehicle starting issues. You need to prevent these objects from touching the coded key while starting the engine. These objects will not cause damage to the coded key, but may cause a momentary issue if they are too close to the key when starting the engine. If a problem occurs, turn the ignition off, remove all objects on the key chain away from the coded key and restart the engine.

Theft indicator

The theft indicator is located on the instrument panel, above the hazard flashers control.

- When the ignition is in the 2 (OFF) position, the indicator will flash once every 2 seconds to indicate the SecuriLock[™] system is functioning as a theft deterrent.
- When the ignition is in the 3 (ON) position, the indicator will glow for 3 seconds, then turn off, to indicate normal system functionality.

If a problem occurs with the SecuriLock[™] system, the indicator will flash rapidly or glow steadily when the ignition is in the 3 (ON) position. If this occurs, the vehicle should be taken to an authorized dealer for service.

Replacement keys

If your keys are lost or stolen and you don't have an extra coded key, you will need to have your vehicle towed to a dealership. The key codes need to be erased from your vehicle and new coded keys will need to be programmed.

Replacing coded keys can be very costly. Store an extra programmed key away from the vehicle in a safe place to help prevent any inconveniences. Please visit an authorized dealer to purchase additional spare or replacement keys.

Programming spare keys

You can program your own coded keys to your vehicle. Please read and understand the entire procedure before you begin.

Tips:

- A maximum of eight keys can be coded to your vehicle.
- Only use SecuriLock[™] keys.
- You must have two previously programmed coded keys (keys that already operate your vehicle's engine) and the new unprogrammed key(s) readily accessible.

Locks and Security

- If two previously programmed coded keys are not available, you must take your vehicle to your dealer to have the spare key(s) programmed.

1. Insert a previously programmed coded key into the ignition.

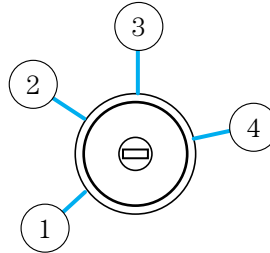

2. Turn the ignition from the 3 (OFF) position to the 4 (ON) position. Keep the ignition in the 4 (ON) position for at least one second, but no more than 10 seconds.

3. Turn the ignition to the 3 (OFF) position.

4. Remove the previously programmed coded key from the ignition.

5. Within ten seconds of removing the previously programmed coded key, insert the other previously programmed coded key into the ignition.

6. Turn the ignition from the 3 (OFF) position to the 4 (ON) position. Keep the ignition in the 4 (ON) position for at least one second but not more than 10 seconds.

7. Turn the ignition to the 3 (OFF) position.

8. Remove the previously programmed coded key from the ignition.

9. Within twenty seconds of removing the previously programmed coded key, insert the unprogrammed key (new/valet key) into the ignition.

10. Turn the ignition from the 3 (OFF) position to the 4 (ON) position. Keep the ignition in the 4 (ON) position for at least one second, but no more than 10 seconds.

11. Your new, unprogrammed key is now programmed.

If the key has been successfully programmed it will start the vehicle's engine and the theft indicator light will illuminate for three seconds and then go out.

If the key was not successfully programmed, it will not start your vehicle's engine and the theft indicator light will flash on and off, or stay on for more than three seconds. If failure repeats, bring your vehicle to your dealer to have the new key(s) programmed.

70

Locks and Security

To program additional new unprogrammed key(s), repeat this procedure from Step 1 for each additional key.

PERIMETER ALARM SYSTEM (IF EQUIPPED)

The perimeter anti-theft system will warn you in the event of an unauthorized entry to your vehicle.

If there is any potential perimeter anti-theft problem with your vehicle, ensure **ALL remote entry transmitters** are taken to the dealership to aid in troubleshooting.

Arming the system

When armed, this system will respond if unauthorized entry is attempted. When unauthorized entry occurs, the system will flash the park/turn lamps and will sound the horn.

The system is ready to arm whenever the key is removed from the ignition. Either of the following actions will prearm the alarm system:

- Press the  control on the remote entry transmitter.
- Lock the doors with the key in the key cylinder.
- Open a door and press the power door lock control to lock all the doors, and then close the door.

Disarming the system

You can disarm the system by any of the following actions:

- Unlock the doors by pressing the  control on your remote entry transmitter.
- Unlock the doors with a key. Turn the key full travel (toward the front of the vehicle) to ensure the alarm disarms.

Triggering the anti-theft system

The armed system will be triggered if any door, liftgate/trunk or the hood is opened without using the key or the remote entry transmitter.

Seating and Safety Restraints

SEATING

Notes:



Reclining the seatback can cause an occupant to slide under the seat's safety belt, resulting in severe personal injuries in the event of a collision.



Do not pile cargo higher than the seatbacks to reduce the risk of injury in a collision or sudden stop.

Adjustable head restraints (if equipped)

Your vehicle's seats may be equipped with head restraints which are vertically adjustable. The purpose of these head restraints is to help limit head motion in the event of a rear collision. To properly adjust your head restraints, lift the head restraint so that it is located directly behind your head or as close to that position as possible. Refer to the following to raise and lower the head restraints.

Push or pull the head restraint to raise it to the desired height. To lower, push the button in the collar around the stem.

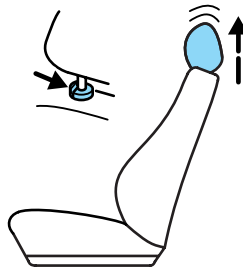

The rear head restraints can be removed altogether if the left-hand locking button is pressed.

Seating and Safety Restraints

Adjusting the front manual seat

Pull the lever located under the front edge of the seat to move the seat forward or backward.

Turn the control to adjust the lumbar support (if equipped).

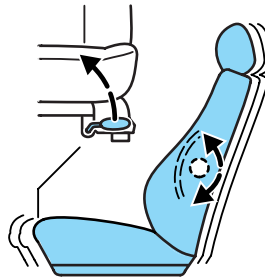

Turn the handle to adjust the height of the seat.

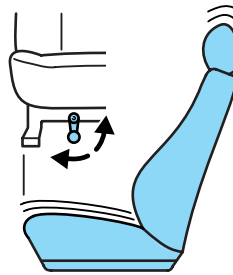

Lift the control to adjust the angle of the seatback.



Seating and Safety Restraints

Heated seats (if equipped)

The heated seats switch is located on the center console.

To operate the heated seats:

- Push control to activate.
- Push again to deactivate.



The maximum temperature is reached after five or six minutes.

The indicator light on the switch is illuminated when activated.

The heating will operate when the ignition switch is in position 2.

Heating with the engine off will drain the battery.

Tip/slide front seat (Coupe)

Lift the control and fold the seatback forward.

The seat can be slid forward to allow easier entry to the rear seats. Slide the seat back and fold back the seatback until it locks with a distinct click. The seatback will return to its original position. Rock the seat to ensure that the catch is securely engaged.



Seating and Safety Restraints

On three door models, front safety belts should be pulled backwards to allow easier entry to or exit from the rear seats.

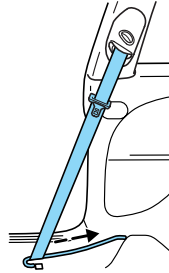

Do not place objects behind the seat which could prevent the engagement of the seat lock.

REAR SEATS

Folding rear seat cushion forward

Lift the seat cushion and pull it forward.

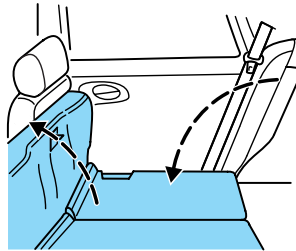

When returning the seats back to their original positions, make sure they are fully locked and that the safety restraints are positioned in front of the seatback.

Seating and Safety Restraints

Folding the rear seat back forward

Coupe and wagon

Remove the head restraints (if equipped) of the rear seats and stow them on the floor behind the front seats.

Push the unlocking control on the rear seatback and fold the rear seatback forward.

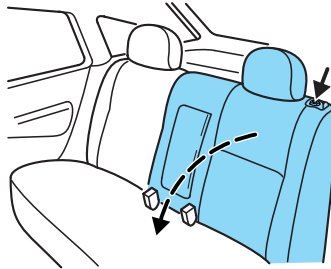

Sedan

Remove the head restraints (if equipped) of the rear seats and stow them on the floor behind the front seats.

Pull one or both of the unlocking controls in the luggage compartment and fold the rear seatback forward.

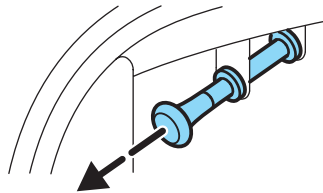

Returning the seatback to the upright position

Fold back the seatback until it locks with a distinct “click.” Do not place any objects behind the seat which could prevent the seat from locking.



When returning the seats back to their original positions, make sure they are fully locked and that the safety restraints are positioned in front of the seatback. Reinstall head restraints (if equipped).

Note that the center rear seat belt cannot be pulled out until the seatback has latched completely.

Seating and Safety Restraints

Folding the seat cushion and seatback forward

Pull the loop between the respective seat cushion and seatback, and fold the seat cushion on that side forward.

Remove the head restraint(s) (if equipped) of the rear seat, and fold the seatback forward.

Stow the head restraint(s) in the plastic retainers provided in the now upright underside of the seat cushion, as shown on the decal.

When returning the seats to their original positions, make sure the safety belts will function properly and are positioned in front of the seatback.

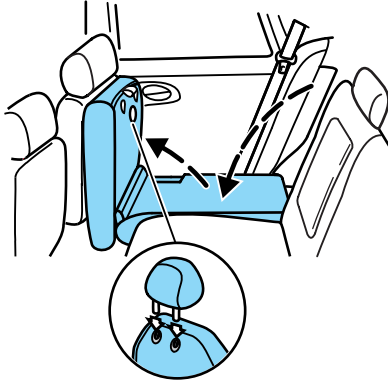

SAFETY RESTRAINTS

Personal Safety System

The Personal Safety System provides an improved overall level of frontal crash protection to front seat occupants and is designed to help further reduce the risk of air bag-related injuries. The system is able to analyze different occupant conditions and crash severity before activating the appropriate safety devices to help better protect a range of occupants in a variety of frontal crash situations.

Your vehicle's Personal Safety System consists of:

- Driver and passenger dual-stage air bag supplemental restraints.
- Front safety belts with pretensioners, energy management retractors, and safety belt usage sensors.
- Driver's seat position sensor.
- Front crash severity sensor.
- Restraints Control Module (RCM) with impact and safing sensors.
- Restraint system warning light and back-up tone.
- The electrical wiring for the air bags, crash sensor(s), safety belt pretensioners, front safety belt usage sensors, driver seat position sensor, and indicator lights.

Seating and Safety Restraints

How does the personal safety system work?

The Personal Safety System can adapt the deployment strategy of your vehicle's safety devices according to crash severity and conditions. A collection of crash sensors provides information to the Restraints Control Module (RCM). During a crash, the RCM activates the safety belt pretensioners and/or either none, one, or both stages of the dual-stage air bag supplemental restraints based on crash severity and conditions.

The fact that the pretensioners or air bags did not activate for both front seat occupants in a collision does not mean that something is wrong with the system. Rather, it means the Personal Safety System determined the accident conditions (crash severity, belt usage, etc.) were not appropriate to activate these safety devices. Front air bags and pretensioners are designed to activate only in frontal and near-frontal collisions, not rollovers, side-impacts, or rear-impacts unless the collision causes sufficient longitudinal deceleration.

Driver and passenger dual-stage air bag supplemental restraints

The dual-stage air bags offer the capability to tailor the level of air bag inflation energy. A lower, less forceful energy level is provided for more common, moderate-severity impacts. A higher energy level is used for the most severe impacts. Refer to *Air bag Supplemental Restraints* section in this chapter.

Front crash severity sensor

The front crash severity sensor enhances the ability to detect the severity of an impact. Positioned up front, it provides valuable information early in the crash event on the severity of the impact. This allows your Personal Safety System to distinguish between different levels of crash severity and modify the deployment strategy of the dual-stage air bags and safety belt pretensioners.

Driver's seat position sensor

The driver's seat position sensor allows your Personal Safety System to tailor the deployment level of the driver dual-stage air bag based on seat position. The system is designed to help protect smaller drivers sitting close to the driver air bag by providing a lower air bag output level.

Front safety belt usage sensors

The front safety belt usage sensors detect whether or not the driver and front outboard passenger safety belts are fastened. This information allows your Personal Safety System to tailor the air bag deployment and safety belt pretensioner activation depending upon safety belt usage. Refer to *Safety Belt* section in this chapter.

Seating and Safety Restraints

Front safety belt pretensioners

The safety belt pretensioners are designed to tighten the safety belts firmly against the occupant's body during a collision. This maximizes the effectiveness of the safety belts and helps properly position the occupant relative to the air bag to improve protection. The safety belt pretensioners can be either activated alone or, if the collision is of sufficient severity, together with the air bags.

Front safety belt energy management retractors

The front safety belt energy management retractors allow webbing to be pulled out of the retractor in a gradual and controlled manner in response to the occupant's forward momentum. This helps reduce the risk of force-related injuries to the occupant's chest by limiting the load on the occupant. Refer to *Safety Belt* section in this chapter.

Determining if the Personal Safety System is operational

The Personal Safety System uses a warning light in the instrument cluster or a back-up tone to indicate the condition of the system. Refer to the *Warning Light* section in the *Instrument Cluster* chapter. Routine maintenance of the Personal Safety System is not required.

The Restraints Control Module (RCM) monitors its own internal circuits and the circuits for the air bag supplemental restraints, crash sensor(s), safety belt pretensioners, front safety belt buckle sensors, and the driver seat position sensor. In addition, the RCM also monitors the restraints warning light in the instrument cluster. A difficulty with the system is indicated by one or more of the following.

- The warning light will either flash or stay lit.
- The warning light will not illuminate immediately after ignition is turned on.
- A series of five beeps will be heard. The tone pattern will repeat periodically until the problem and warning light are repaired.

If any of these things happen, even intermittently, have the Personal Safety System serviced at your dealership or by a qualified technician immediately. Unless serviced, the system may not function properly in the event of a collision.

Seating and Safety Restraints

Safety belt precautions



Always drive and ride with your seatback upright and the lap belt snug and low across the hips.



To reduce the risk of injury, make sure children sit where they can be properly restrained.



Never let a passenger hold a child on his or her lap while the vehicle is moving. The passenger cannot protect the child from injury in a collision.



All occupants of the vehicle, including the driver, should always properly wear their safety belts, even when an air bag supplemental restraint system (SRS) is provided.



It is extremely dangerous to ride in a cargo area, inside or outside of a vehicle. In a collision, people riding in these areas are more likely to be seriously injured or killed. Do not allow people to ride in any area of your vehicle that is not equipped with seats and safety belts. Be sure everyone in your vehicle is in a seat and using a safety belt properly.



In a rollover crash, an unbelted person is significantly more likely to die than a person wearing a seat belt.



Each seating position in your vehicle has a specific safety belt assembly which is made up of one buckle and one tongue that are designed to be used as a pair. 1) Use the shoulder belt on the outside shoulder only. Never wear the shoulder belt under the arm. 2) Never swing the safety belt around your neck over the inside shoulder. 3) Never use a single belt for more than one person.



Always transport children 12 years old and under in the back seat and always properly use appropriate child restraints.

Seating and Safety Restraints

Combination lap and shoulder belts

1. Insert the belt tongue into the proper buckle (the buckle closest to the direction the tongue is coming from) until you hear a snap and feel it latch. Make sure the tongue is securely fastened in the buckle.

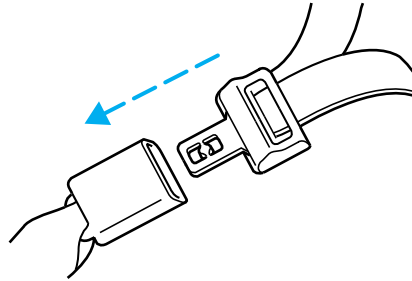

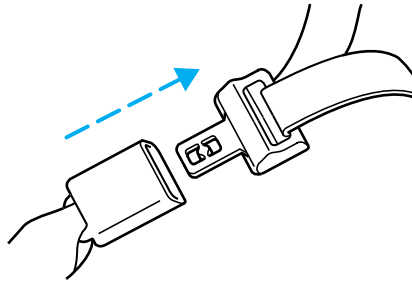

2. To unfasten, push the release button and remove the tongue from the buckle.



Energy management feature

- This vehicle has a seat belt system with an energy management feature at the front outboard seating positions to help further reduce the risk of injury in the event of a head-on collision.
- This seat belt system has a retractor assembly that is designed to pay out webbing in a controlled manner. This feature is designed to help reduce the belt force acting on the occupant's chest.

 BELT AND RETRACTOR ASSEMBLY MUST BE REPLACED if the seat belt assembly “automatic locking retractor” feature or any other seat belt function is not operating properly when checked according to the procedures in Workshop Manual.

 Failure to replace the belt and retractor assembly could increase the risk of injury in collisions.

Seating and Safety Restraints

The front outboard and rear safety restraints in the vehicle are combination lap and shoulder belts. The front passenger and rear seat safety belts have two types of locking modes.

Vehicle sensitive mode

The vehicle sensitive mode is the normal retractor mode, allowing free shoulder belt length adjustment to your movements and locking in response to vehicle movement. For example, if the driver brakes suddenly or turns a corner sharply, or the vehicle receives an impact of approximately 8 km/h (5 mph) or more, the combination safety belts will lock to help reduce forward movement of the driver and passengers.

Automatic locking mode

The automatic locking mode is not available on the driver safety belt.

When to use the automatic locking mode

In this mode, the shoulder belt is automatically pre-locked. The belt will still retract to remove any slack in the shoulder belt. The automatic locking mode is not available on the driver safety belt.

This mode should be used **any time** a child safety seat is installed in a passenger front or outboard rear seating position (if equipped). Children 12 years old and under should be properly restrained in the rear seat whenever possible. Refer to *Safety restraints for children* or *Safety seats for children* later in this chapter.

How to use the automatic locking mode

- Buckle the combination lap and shoulder belt.

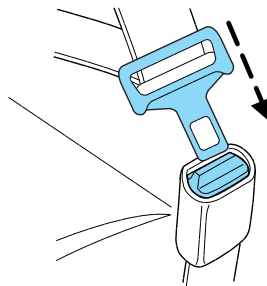

Seating and Safety Restraints

- Grasp the shoulder portion and pull downward until the entire belt is pulled out.



- Allow the belt to retract. As the belt retracts, you will hear a clicking sound. This indicates the safety belt is now in the automatic locking mode.

How to disengage the automatic locking mode



Ford Motor Company recommends that all passenger safety belt assemblies and attaching hardware should be inspected by a qualified technician after any collision to verify that the "automatic locking retractor" feature for child seats is still working properly. Safety belt assemblies should be inspected according to the procedures in the Workshop Manual and replaced if either damage or improper operation is noted. Failure to replace the belt and retractor assembly could increase the risk of injury in a collision.

Unbuckle the combination lap/shoulder belt and allow it to retract completely to disengage the automatic locking mode and activate the vehicle sensitive (emergency) locking mode.

Safety belt pretensioner

Your vehicle is equipped with safety belt pretensioners at the driver and front outboard passenger seating positions.

The safety belt pretensioner is a device which removes excess webbing from the safety belt system. The safety belt pretensioner uses the same crash sensor system as the front air bag supplemental restraint system (SRS). When the safety belt pretensioner deploys, webbing from the lap and shoulder belt is tightened. The driver and front passenger seat belt system (including retractors, buckles and height adjusters) must be replaced if the vehicle is involved in a collision that results in deployment of front air bags and safety belt pretensioners. Refer to the *Safety belt maintenance* section in this chapter.

Seating and Safety Restraints

 Failure to replace the safety belt assembly under the above conditions could result in severe personal injuries in the event of a collision.

Front safety belt height adjustment

Adjust the height of the shoulder belt so the belt rests across the middle of your shoulder.

To adjust the shoulder belt height, push the button and slide the height adjuster up or down. Release the button and pull down on the height adjuster to make sure it is locked in place.

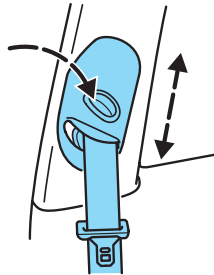

Three door models are equipped with a safety belt parking feature for the driver and front passenger. The purpose of the parking feature is to allow the driver or passenger to reach the safety belt. Fasten your safety belt as normal, and the belt will slide to the front of the steel bar along the bottom of the door. Pull the safety belt backwards to park for easier access or exit from the rear seats.

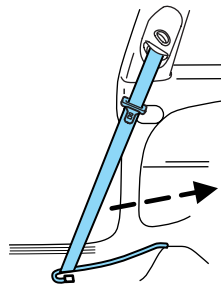

 Position the safety belt height adjusters so that the belt rests across the middle of your shoulder. Failure to adjust the safety belt properly could reduce the effectiveness of the seat belt and increase the risk of injury in a collision.

Safety belt warning light and indicator chime

The safety belt warning light illuminates in the instrument cluster and a chime sounds to remind the occupants to fasten their safety belts.

Seating and Safety Restraints

Conditions of operation

If...	Then...
The driver's safety belt is not buckled before the ignition switch is turned to the ON position...	The safety belt warning light illuminates 1-2 minutes and the warning chime sounds 4-8 seconds.
The driver's safety belt is buckled while the indicator light is illuminated and the warning chime is sounding...	The safety belt warning light and warning chime turn off.
The driver's safety belt is buckled before the ignition switch is turned to the ON position...	The safety belt warning light and indicator chime remain off.

BeltMinder

The BeltMinder feature is a supplemental warning to the safety belt warning function. This feature provides additional reminders to the driver that the driver's safety belt is unbuckled by intermittently sounding a chime and illuminating the safety belt warning lamp in the instrument cluster.

If...	Then...
The driver's safety belt is not buckled approximately 5 seconds after the safety belt warning light has turned off...	The BeltMinder feature is activated - the safety belt warning light illuminates and the warning chime sounds for 6 seconds every 30 seconds, repeating for approximately 5 minutes or until safety belt is buckled.
The driver's safety belt is buckled while the safety belt indicator light is illuminated and the safety belt warning chime is sounding...	The BeltMinder feature will not activate.
The driver's safety belt is buckled before the ignition switch is turned to the ON position...	The BeltMinder feature will not activate.

Seating and Safety Restraints

The following are reasons most often given for not wearing safety belts:
(All statistics based on U.S. data)

Reasons given...	Consider...
"Crashes are rare events"	36700 crashes occur every day. The more we drive, the more we are exposed to "rare" events, even for good drivers. <i>1 in 4 of us will be seriously injured in a crash during our lifetime.</i>
"I'm not going far"	3 of 4 fatal crashes occur within 25 miles of home.
"Belts are uncomfortable"	We design our safety belts to enhance comfort. If you are uncomfortable - try different positions for the safety belt upper anchorage and seatback which should be as upright as possible; this can improve comfort.
"I was in a hurry"	Prime time for an accident. BeltMinder reminds us to take a few seconds to buckle up.
"Safety belts don't work"	Safety belts , when used properly, reduce risk of death to front seat occupants by 45% in cars , and by 60% in light trucks .
"Traffic is light"	Nearly 1 of 2 deaths occur in single-vehicle crashes , many when no other vehicles are around.
"Belts wrinkle my clothes"	Possibly, but a serious crash can do much more than wrinkle your clothes, particularly if you are unbelted.
"The people I'm with don't wear belts"	Set the example, teen deaths occur 4 times more often in vehicles with TWO or MORE people. Children and younger brothers/sisters imitate behavior they see.

Seating and Safety Restraints

Reasons given...	Consider...
"I have an air bag"	Air bags offer greater protection when used with safety belts. Frontal airbags are not designed to inflate in rear and side crashes or rollovers.
"I'd rather be thrown clear"	Not a good idea. People who are ejected are 40 times more likely to DIE . Safety belts help prevent ejection, WE CAN'T "PICK OUR CRASH".

 Do not sit on top of a buckled safety belt to avoid the Belt Minder chime. Sitting on the safety belt will increase the risk of injury in an accident. To disable (one-time) or deactivate the Belt Minder feature please follow the directions stated below.

One time disable

Any time the safety belt is buckled and then unbuckled during an ignition ON cycle, the BeltMinder will be disabled for that ignition cycle only.

Deactivating/activating the BeltMinder feature

Read steps 1 - 9 thoroughly before proceeding with the deactivation/activation programming procedure.

The BeltMinder feature can be deactivated/activated by performing the following procedure:

Before following the procedure, ensure that the following conditions are met:

- The parking brake is set.
- The gearshift is in P (Park) (automatic transmission) or the neutral position (manual transmission).
- The ignition switch is in the OFF position.
- All vehicle doors are closed.
- The driver's safety belt is unbuckled.
- The parklamps/headlamps are in OFF position (If vehicle is equipped with Autolamps, this will not affect the procedure).

 To reduce the risk of injury, do not deactivate/activate the Belt Minder feature while driving the vehicle.

Seating and Safety Restraints

BeltMinder activation and deactivation procedure

1. Turn the ignition switch to the RUN (or ON) position. (DO NOT START THE ENGINE.)
2. Wait until the safety belt warning light turns off. (Approximately 1–2 minutes.)
 - Steps 3–5 must be completed within 60 seconds or the procedure will have to be repeated.
3. Buckle then unbuckle the safety belt three times, ending with the safety belt unbuckled. This can be done before or during BeltMinder warning activation.
4. Turn on the parklamps/headlamps, turn off the parklamps/headlamps.
5. Buckle then unbuckle the safety belt three times, ending with the safety belt unbuckled.
 - After step 5 the safety belt warning light will be turned on for three seconds.
6. Within seven seconds of the safety belt warning light turning off, buckle then unbuckle the safety belt.
 - This will disable BeltMinder if it is currently enabled, or enable BeltMinder if it is currently disabled.
7. Confirmation of disabling BeltMinder is provided by the safety belt warning light flashing four times per second for three seconds.
8. Confirmation of enabling BeltMinder is provided by:
 - The safety belt warning light flashing four times per second for three seconds.
 - Followed by three seconds with the safety belt warning light off.
 - Once again, the safety belt warning light will flash four times per second for three seconds.
9. After receiving confirmation, the deactivation/activation procedure is complete.

Seating and Safety Restraints

Safety belt extension assembly

If the safety belt is too short when fully extended, there is a 20 cm (8 inch) safety belt extension assembly that can be added (part number 611C22). This assembly can be obtained from your dealer at no cost.

Use only extensions manufactured by the same supplier as the safety belt. Manufacturer identification is located at the end of the webbing on the label. Also, use the safety belt extension only if the safety belt is too short for you when fully extended.



Do not use extensions to change the fit of the shoulder belt across the torso.

Safety belt maintenance

Inspect the safety belt systems periodically to make sure they work properly and are not damaged. Inspect the safety belts to make sure there are no nicks, tears or cuts. Replace if necessary. All safety belt assemblies, including retractors, buckles, front seat belt buckle assemblies, buckle support assemblies (slide bar-if equipped), shoulder belt height adjusters (if equipped), shoulder belt guide on seatback (if equipped), child safety seat LATCH and tether anchors, and attaching hardware, should be inspected after a collision. Ford Motor Company recommends that all safety belt assemblies in use in vehicles involved in a collision be replaced. However, if the collision was minor and a qualified technician finds that the belts do not show damage and continue to operate properly, they do not need to be replaced. Safety belt assemblies not in use during a collision should also be inspected and replaced if either damage or improper operation is noted.



Failure to inspect and if necessary replace the safety belt assembly under the above conditions could result in severe personal injuries in the event of a collision.

Refer to *Interior* in the *Cleaning* chapter.

Seating and Safety Restraints

AIR BAG SUPPLEMENTAL RESTRAINT SYSTEM (SRS)

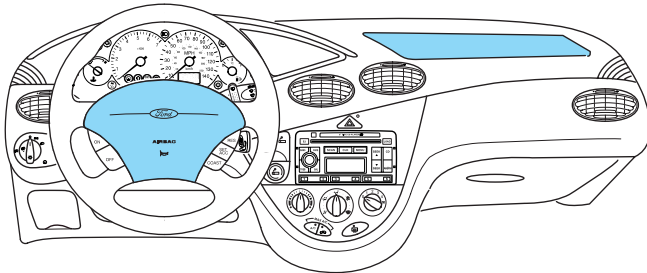



The supplemental restraint system is designed to work with the safety belt to help protect the driver and right front passenger from certain upper body injuries.

 Air bags **DO NOT** inflate slowly or gently, and the risk of injury from a deploying air bag is the greatest close to the trim covering the air bag module.

Important SRS precautions

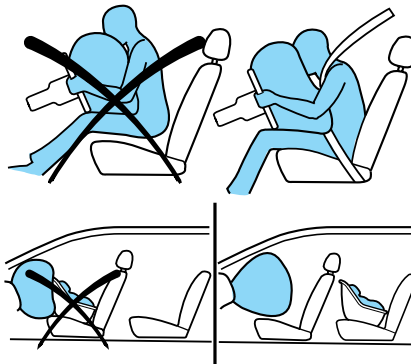
The SRS is designed to work with the safety belt to help protect the driver and right front passenger from certain upper body injuries. Air bags **DO NOT** inflate slowly; there is a risk of injury from a deploying air bag.



 All occupants of the vehicle, including the driver, should always properly wear their safety belts, even when an air bag supplemental restraint system (SRS) is provided.

Seating and Safety Restraints



Always transport children 12 years old and under in the back seat and always properly use appropriate child restraints.



The National Highway Traffic Safety Administration (NHTSA) recommends a minimum distance of at least 25 cm (10 inches) between an occupant's chest and the driver air bag module.



Never place your arm over the air bag module as a deploying air bag can result in serious arm fractures or other injuries.

To properly position yourself away from the air bag:

- Move your seat to the rear as far as you can while still reaching the pedals comfortably.
- Recline the seat slightly one or two degrees from the upright position.



Do not put anything on or over the air bag module. Placing objects on or over the air bag inflation area may cause those objects to be propelled by the air bag into your face and torso causing serious injury.



Do not attempt to service, repair, or modify the air bag supplemental restraint systems or its fuses. See your Ford or Lincoln Mercury dealer.

Seating and Safety Restraints

Children and air bags

Children must always be properly restrained. Accident statistics suggest that children are safer when properly restrained in the rear seating positions than in the front seating position. Failure to follow these instructions may increase the risk of injury in a collision.

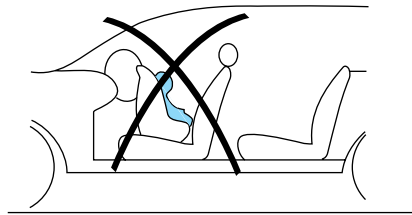

Air bags can kill or injure a child in a child seat.

NEVER place a rear-facing child seat in front of an active air bag. If you must use a forward-facing child seat in the front seat, move the seat all the way back.

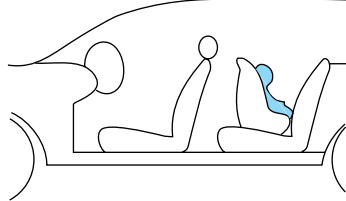

How does the air bag supplemental restraint system work?

The air bag SRS is designed to activate when the vehicle sustains longitudinal deceleration sufficient to cause the sensors to close an electrical circuit that initiates air bag inflation. The fact that the air bags did not inflate in a collision does not mean that something is wrong with the system. Rather, it means the forces were not of the type sufficient to cause activation.

Front air bags are designed to inflate in frontal and near-frontal collisions, not rollover, side-impact, or rear-impacts unless the collision causes sufficient longitudinal deceleration.

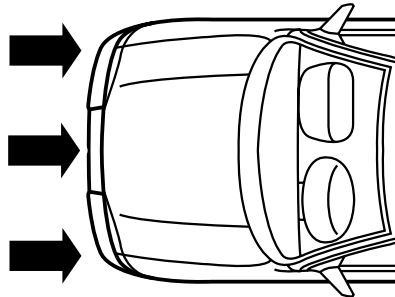

Seating and Safety Restraints

The air bags inflate and deflate rapidly upon activation. After air bag deployment, it is normal to notice a smoke-like, powdery residue or smell the burnt propellant. This may consist of cornstarch, talcum powder (to lubricate the bag) or sodium compounds (e.g., baking soda) that result from the combustion process that inflates the air bag. Small amounts of sodium hydroxide may be present which may irritate the skin and eyes, but none of the residue is toxic.



While the system is designed to help reduce serious injuries, contact with a deploying air bag may also cause abrasions, swelling or temporary hearing loss. Because air bags must inflate rapidly and with considerable force, there is the risk of death or serious injuries such as fractures, facial and eye injuries or internal injuries, particularly to occupants who are not properly restrained or are otherwise out of position at the time of air bag deployment. Thus, it is extremely important that occupants be properly restrained as far away from the air bag module as possible while maintaining vehicle control.



Several air bag system components get hot after inflation. Do not touch them after inflation.



If the air bag has deployed, **the air bag will not function again and must be replaced immediately.** If the air bag is not replaced, the unrepaired area will increase the risk of injury in a collision.

The SRS consists of:

- driver and passenger air bag modules (which include the inflators and air bags).
- side air bags (if equipped). Refer to *Side air bag system* later in this chapter.
- one or more impact and safing sensors.
- a readiness light and tone.

Seating and Safety Restraints

- diagnostic module.
- and the electrical wiring which connects the components.

The diagnostic module monitors its own internal circuits and the supplemental air bag electrical system wiring (including the impact sensors), the system wiring, the air bag system readiness light, the air bag back up power and the air bag ignitors.

Determining if the system is operational

The supplemental restraint system uses a warning indicator in the instrument cluster or a back-up tone to indicate the condition of the system. Refer to the *Warning light* section in the *Instrument cluster* chapter. Routine maintenance of the air bag is not required.

A difficulty with the system is indicated by one or more of the following:

- The readiness light (same light for front and side air bag system) will either flash or stay lit.
- The readiness light will not illuminate immediately after ignition is turned on.
- A series of five beeps will be heard. The tone pattern will repeat periodically until the problem and/or light are repaired.



If any of these things happen, even intermittently, have the supplemental restraint system serviced at your dealership or by a qualified technician immediately. Unless serviced, the system may not function properly in the event of a collision.

Side air bag system (if equipped)



Do not place objects or mount equipment on or near the air bag cover on the side of the seatbacks of the front seats or in front seat areas that may come into contact with a deploying air bag. Failure to follow these instructions may increase the risk of personal injury in the event of a collision.



Do not use accessory seat covers. The use of accessory seat covers may prevent the deployment of the side air bags and increase the risk of injury in an accident.

Seating and Safety Restraints



Do not lean your head on the door. The side air bag could injure you as it deploys from the side of the seatback.



Do not attempt to service, repair, or modify the air bag SRS, its fuses or the seat cover on a seat containing an air bag. See your Ford or Lincoln Mercury dealer.



All occupants of the vehicle should always wear their safety belts even when an air bag SRS is provided.

How does the side air bag system work?

The side air bag system consists of the following:

- An inflatable nylon bag (air bag) with a gas generator concealed behind the outboard bolster of the driver and front passenger seatbacks.
- A special seat cover designed to allow air bag deployment.
- The same warning light, electronic control and diagnostic unit as used for the front air bags.
- Two crash sensors located under the outboard side of the front seats, attached to the floor.

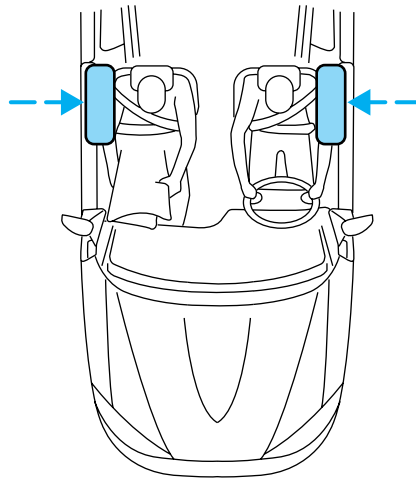

Side air bags, in combination with seat belts, can help reduce the risk of severe injuries in the event of a significant side impact collision.

The side air bags are fitted on the outboard side of the seatbacks of the front seats. In certain lateral collisions, the air bag on the side affected by the collision will be inflated, even if the respective seat is not occupied. The air bag was designed to inflate between the door panel and occupant to further enhance the protection provided occupants in side impact collisions.

The air bag SRS is designed to activate when the vehicle sustains lateral deceleration sufficient to cause the sensors to close an electrical circuit that initiates air bag inflation.

Seating and Safety Restraints

The fact that the air bags did not inflate in a collision does not mean that something is wrong with the system. Rather, it means the forces were not of the type sufficient to cause activation. Side air bags are designed to inflate in side-impact collisions, not roll-over, rear-impact, frontal or near-frontal collisions, unless the collision causes sufficient lateral deceleration.



Several air bag system components get hot after inflation. Do not touch them after inflation.



If the side air bag has deployed, **the air bag will not function again. The side air bag system (including the seat) must be inspected and serviced by a qualified technician in accordance with the vehicle service manual.** If the air bag is not replaced, the unrepaired area will increase the risk of injury in a collision.

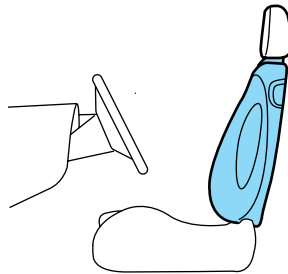

Disposal of air bags and air bag equipped vehicles

For disposal of air bags or air bag equipped vehicles, see your local dealership or qualified technician. Air bags **MUST BE** disposed of by qualified personnel.

SAFETY RESTRAINTS FOR CHILDREN

See the following sections for directions on how to properly use safety restraints for children. Also see *Air bag supplemental restraint system (SRS)* in this chapter for special instructions about using air bags.



Rear-facing child seats or infant carriers should never be placed in the front seats.



Always transport children 12 years old and under in the back seat and always use appropriate child restraints.

Seating and Safety Restraints

Accident statistics indicate that children are safer when properly restrained in the rear seats.



Do not leave children, unreliable adults, or pets unattended in your vehicle.



Safety belts and seats can become hot in a vehicle that has been closed up in sunny weather, they could burn a small child. Check seat covers and buckles before you place a child anywhere near them.

Important child restraint precautions

You are required by law to use safety restraints for children in the U.S. and Canada. If small children (generally children who are four years old or younger and who weigh 18 kg [40 lbs] or less) ride in your vehicle, you must put them in safety seats made especially for children. Many states require that children use approved booster seats until they are eight years old. Check your local and state or provincial laws for specific requirements regarding the safety of children in your vehicle. When possible, always place children under age 12 in the rear seat of your vehicle. Accident statistics suggest that children are safer when properly restrained in the rear seating positions than in the front seating position.



Never let a passenger hold a child on his or her lap while the vehicle is moving. The passenger cannot protect the child from injury in a collision.

Always follow the instructions and warnings that come with any infant or child restraint you might use.

Children and safety belts

If the child is the proper size, restrain the child in a safety seat. Children who are too large for child safety seats (as specified by your child safety seat manufacturer) should always wear safety belts.

Follow all the important safety restraint and air bag precautions that apply to adult passengers in your vehicle.

If the shoulder belt portion of a combination lap and shoulder belt can be positioned so it does not cross or rest in front of the child's face or neck, the child should wear the lap and shoulder belt. Moving the child closer to the center of the vehicle may help provide a good shoulder belt fit.

Seating and Safety Restraints



Do not leave children, unreliable adults, or pets unattended in your vehicle.

Child booster seats

Children outgrow a typical convertible or toddler seat when they weigh 40 pounds and are around 4 years of age. Although the lap/shoulder belt will provide some protection, these children are still too small for lap/shoulder belts to fit properly, which could increase the risk of serious injury.

To improve the fit of both the lap and shoulder belt on children who have outgrown child safety seats, Ford Motor Company recommends use of a belt-positioning booster.

Booster seats position a child so that safety belts fit better. They lift the child up so that the lap belt rests low across the hips and the knees bend comfortably. Booster seats also make the shoulder belt fit better and more comfortably for growing children.

When children should use booster seats

Children need to use booster seats from the time they outgrow the toddler seat until they are big enough for the vehicle seat and lap/shoulder belt to fit properly. Generally this is when they weigh about 80 lbs (about 8 to 12 years old).

Booster seats should be used until you can answer YES to ALL of these questions:

- Can the child sit all the way back against the vehicle seat back with knees bent comfortably at the edge of the seat without slouching?

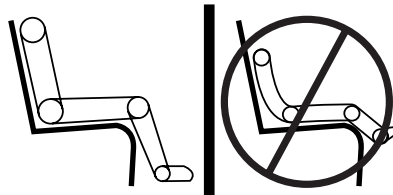

- Does the lap belt rest low across the hips?
- Is the shoulder belt centered on the shoulder and chest?
- Can the child stay seated like this for the whole trip?

Seating and Safety Restraints

Types of booster seats

There are two types of belt-positioning booster seats:

- Those that are backless.

If your backless booster seat has a removable shield, remove the shield and use the lap/shoulder belt. If a seating position has a low seat back and no head restraint, a backless booster seat may place your child's head (top of ear level) above the top of the seat. In this case, move the backless booster to another seating position with a higher seat back and lap/shoulder belts.



- Those with a high back.

If, with a backless booster seat, you cannot find a seating position that adequately supports your child's head, a high back booster seat would be a better choice.



Both can be used in any vehicle in a seating position equipped with lap/shoulder belts if your child is over 40 lbs.

The shoulder belt should cross the chest, resting snugly on the center of the shoulder. The lap belt should rest low and snug across the hips, never up high across the stomach.

If the booster seat slides on the vehicle seat, placing a rubberized mesh sold as shelf or carpet liner under the booster seat may improve this condition.

The importance of shoulder belts

Using a booster without a shoulder belt increases the risk of a child's head hitting a hard surface in a collision. For this reason, you should never use a booster seat with a lap belt only. It is best to use a booster seat with lap/shoulder belts in the back seat- the safest place for children to ride.

Seating and Safety Restraints



Follow all instructions provided by the manufacturer of the booster seat.



Never put the shoulder belt under a child's arm or behind the back because it eliminates the protection for the upper part of the body and may increase the risk of injury or death in a collision.



Never use pillows, books, or towels to boost a child. They can slide around and increase the likelihood of injury or death in a collision.

SAFETY SEATS FOR CHILDREN

Child and infant or child safety seats

Use a safety seat that is recommended for the size and weight of the child. Carefully follow all of the manufacturer's instructions with the safety seat you put in your vehicle. If you do not install and use the safety seat properly, the child may be injured in a sudden stop or collision.

When installing a child safety seat:

- Review and follow the information presented in the *Air bag supplemental restraint system (SRS)* section in this chapter.
- Use the correct safety belt buckle for that seating position (the buckle closest to the direction the tongue is coming from).
- Insert the belt tongue into the proper buckle until you hear a snap and feel it latch. Make sure the tongue is securely fastened in the buckle.
- Keep the buckle release button pointing up and away from the safety seat, with the tongue between the child seat and the release button, to prevent accidental unbuckling.
- Place seat back in upright position.

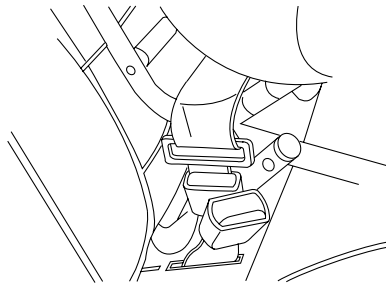

Seating and Safety Restraints

- Put the safety belt in the automatic locking mode. Refer to *Automatic locking mode* (passenger side front and outboard rear seating positions) (if equipped) section in this chapter.
- LATCH lower anchors are recommended for use by children up to 22 kg (48 pounds) in a child restraint. Top tether anchors can be used for children up to 27 kg (60 pounds) in a child restraint, and to provide upper torso restraint for children up to 36 kg (80 pounds) using an upper torso harness and a belt-positioning booster.

Ford recommends the use of a child safety seat having a top tether strap. Install the child safety seat in a seating position with LATCH and tether anchors. For more information on top tether straps and anchors, refer to *Attaching safety seats with tether straps* in this chapter. For more information of LATCH anchors refer to *Attaching safety seats with LATCH (Lower Anchors and Tethers for Children) attachments* in this chapter.



Carefully follow all of the manufacturer's instructions included with the safety seat you put in your vehicle. If you do not install and use the safety seat properly, the child may be injured in a sudden stop or collision.



Rear-facing child seats or infant carriers should never be placed in the front seats.

Installing child safety seats with combination lap and shoulder belts



Air bags can kill or injure a child in a child seat. **NEVER** place a rear-facing child seat in front of an active air bag. If you must use a forward-facing child seat in the front seat, move the seat all the way back.



Children 12 and under should be properly restrained in the rear seat whenever possible.

Seating and Safety Restraints

1. Position the child safety seat in a seat with a combination lap and shoulder belt.

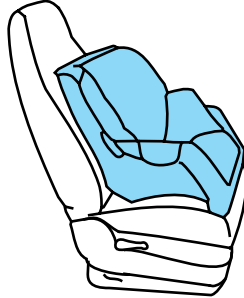

2. Pull down on the shoulder belt and then grasp the shoulder belt and lap belt together.

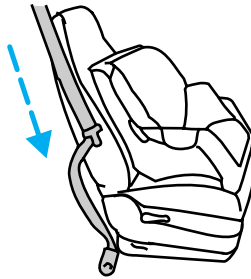

3. While holding the shoulder and lap belt portions together, route the tongue through the child seat according to the child seat manufacturer's instructions. Be sure the belt webbing is not twisted.

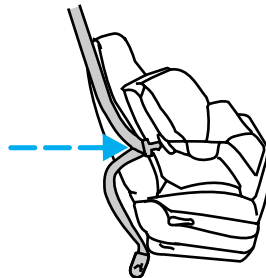

Seating and Safety Restraints

4. Insert the belt tongue into the proper buckle (the buckle closest to the direction the tongue is coming from) for that seating position until you hear a snap and feel the latch engage. Make sure the tongue is latched securely by pulling on it.

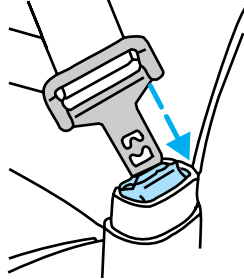

5. To put the retractor in the automatic locking mode, grasp the shoulder portion of the belt and pull downward until all of the belt is pulled out and a click is heard.

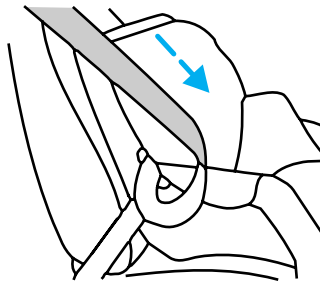

6. Allow the belt to retract. The belt will click as it retracts to indicate it is in the automatic locking mode.

7. Pull the lap belt portion across the child seat toward the buckle and pull up on the shoulder belt while pushing down with your knee on the child seat.

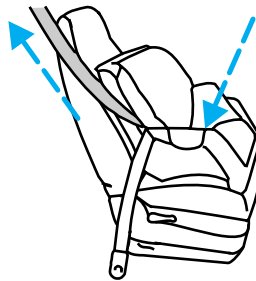

Seating and Safety Restraints

8. Allow the safety belt to retract to remove any slack in the belt.

9. Before placing the child in the seat, forcibly move the seat forward and back to make sure the seat is securely held in place. To check this, grab the seat at the belt path and attempt to move it side to side and forward. There should be no more than one inch of movement for proper installation.

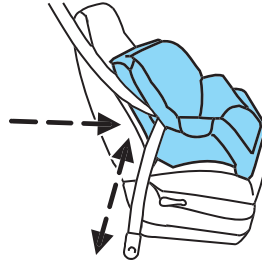

10. Try to pull the belt out of the retractor to make sure the retractor is in the automatic locking mode (you should not be able to pull more belt out). If the retractor is not locked, unbuckle the belt and repeat steps two through nine.

Check to make sure the child seat is properly secured before each use.

Attaching child safety seats with tether straps

Most new forward-facing child safety seats include a tether strap which goes over the back of the seat and hooks to an anchoring point. Tether straps are available as an accessory for many older safety seats. Contact the manufacturer of your child seat for information about ordering a tether strap.

The rear seats of your vehicle are equipped with built-in tether strap anchors located behind the seats as described below.

The tether anchors in your vehicle are either located under a cover marked with the tether anchor symbol (shown with title) or are recessed bars on the back side of the seatback.

The tether strap anchors in your vehicle are in the following positions (shown from top view, left is front of the vehicle):

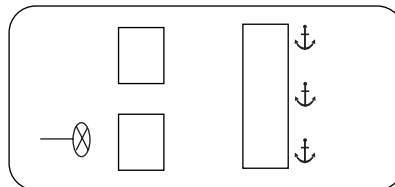

Attach the tether strap only to the appropriate tether anchor as shown. The tether strap may not work properly if attached somewhere other than the correct tether anchor.

Seating and Safety Restraints

1. Position the child safety seat on the seat cushion.
2. Route the child safety seat tether strap over the back of the seat.

On hatchbacks, the removable luggage area cover must be removed prior to attaching the tether strap to the tether anchor.

On wagons, it may be necessary to remove the cargo cover assembly prior to attaching the tether strap to the tether anchor. The tether must not go around the cargo cover retractor assembly.

For vehicles with adjustable head restraints, route the tether strap under the head restraint and between the head restraint posts, otherwise route the tether strap over the top of the seatback.

3. Locate the correct anchor for the selected seating position.

- On Sedan's the anchors are located on the rear back panel.



- For Coupe and Wagon, the anchors are located on the back of the rear seat.

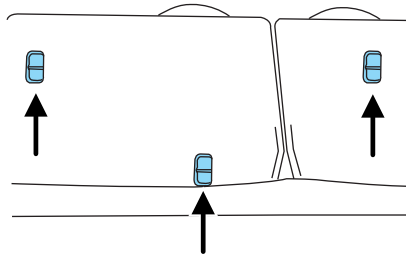

4. On a sedan, open the tether anchor cover.

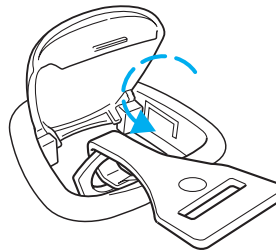

Seating and Safety Restraints

5. Clip the tether strap to the anchor as shown.

 If the tether strap is clipped incorrectly, the child safety seat may not be retained properly in the event of a collision.

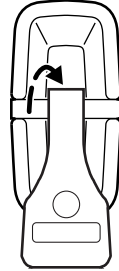

6. Install the child safety seat tightly using the LATCH anchors or safety belts. Follow the instructions in this chapter.

7. Tighten the child safety seat tether strap according to the manufacturer's instructions.

 If the safety seat is not anchored properly, the risk of a child being injured in a collision greatly increases.

Attaching child safety seats with Lower Anchor and Tethers for Children (LATCH) attachments for child seat anchors

LATCH lower anchors are recommended for use by children up to 22 kg (48 pounds) in a child restraint. Top tether anchors can be used for children up to 27 kg (60 pounds) in a child restraint, and to provide upper torso restraint for children up to 36 kg (80 pounds) using an upper torso harness and a belt-positioning booster.

Some child safety seats have two rigid or webbing mounted attachments that connect to two anchors at specific seating positions in your vehicle. This type of child seat eliminates the need to use seat belts to attach the child seat. For forward-facing child seats, the tether strap must also be attached to the proper tether anchor point. For information on using tether straps with the child safety seats, refer to *Attaching safety seats with tether straps* in this chapter.

Seating and Safety Restraints

LATCH anchors for child seat installation have been provided in your vehicle at the following locations:

The anchors on both sides of the center of the rear seat are provided primarily for child seats at the outboard seats and are further apart

than the pairs of lower anchors for child seat installation at other seats. A child seat with rigid LATCH attachments cannot be installed at the center rear seat. A child seat with LATCH attachments on belt webbing can be used at the center rear seat unless a child seat at an outboard rear seat is attached to one of these lower anchors. Install a child seat onto the lower anchors at the center rear seat **ONLY IF** the child restraint manufacturer recommends that the child seat can be installed to anchors that are spaced up to 450 mm apart.

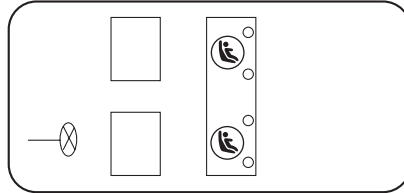

Never attach two LATCH child safety seats to the same anchor. In a crash, one anchor may not be strong enough to hold two child seat attachments and may break, causing serious injury or death.

The LATCH anchors are located on the rear section of the seat cushion, at the bottom of the seatback.

Follow the child seat manufacturer's instructions to properly install safety seats with LATCH attachments.

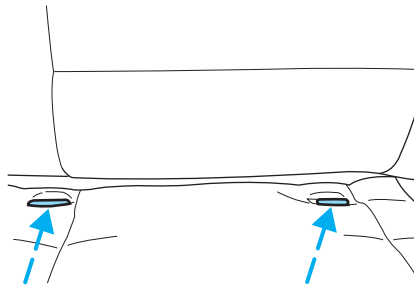

Attach the LATCH lower attachments of the child seat only to the appropriate locations shown.

Once you have installed the LATCH safety seat, assure that the seat is properly attached to LATCH and tether anchors. Also, test the safety seat before you place the child in it. Tilt the seat from side to side. Also try to tug the seat forward. Check to see if the anchors hold the seat in place.



If the safety seat is not anchored properly, the risk of a child being injured in a collision greatly increases.

Driving

STARTING

Positions of the ignition

1. LOCK, locks the steering wheel, automatic transaxle gearshift lever and allows key removal.

2. OFF, shuts the engine and all electrical accessories off without locking the steering wheel. The audio system will still function.

3. ON, all electrical circuits operational. Warning lights illuminated. Key position when driving.

4. START, cranks the engine. Release the key as soon as the engine starts.

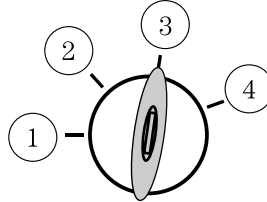

Preparing to start your vehicle

Engine starting is controlled by the powertrain control system. This system meets all Canadian Interference-Causing Equipment standard requirements regulating the impulse electrical field strength of radio noise.

When starting a fuel-injected engine, don't press the accelerator before or during starting. Only use the accelerator when you have difficulty starting the engine. For more information on starting the vehicle, refer to *Starting the engine* in this chapter.



Extended idling at high engine speeds can produce very high temperatures in the engine and exhaust system, creating the risk of fire or other damage.



Do not park, idle, or drive your vehicle in dry grass or other dry ground cover. The emission system heats up the engine compartment and exhaust system, which can start a fire.



Do not start your vehicle in a closed garage or in other enclosed areas. Exhaust fumes can be toxic. Always open the garage door before you start the engine. See *Guarding against exhaust fumes* in this chapter for more instructions.

Driving



If you smell exhaust fumes inside your vehicle, have your dealer inspect your vehicle immediately. Do not drive if you smell exhaust fumes.

Important safety precautions

When the engine starts, the idle RPM runs faster to warm the engine. If the engine idle speed does not slow down automatically, have the vehicle checked.

Before starting the vehicle:

1. Make sure all occupants buckle their safety belts. For more information on safety belts and their proper usage, refer to the *Seating and Safety Restraints* chapter.
2. Make sure the headlamps and electrical accessories are off.

If starting a vehicle with an automatic transaxle:

- Make sure the parking brake is set.

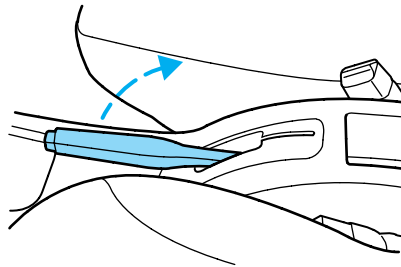

- Make sure the gearshift is in P (Park).

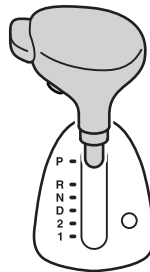

Driving

If starting a vehicle with a manual transaxle:

1. Make sure the parking brake is set.
2. Push the clutch pedal to the floor.

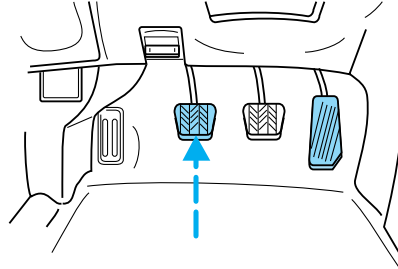

- Turn the key to 3 (ON) without turning the key to 4 (START).

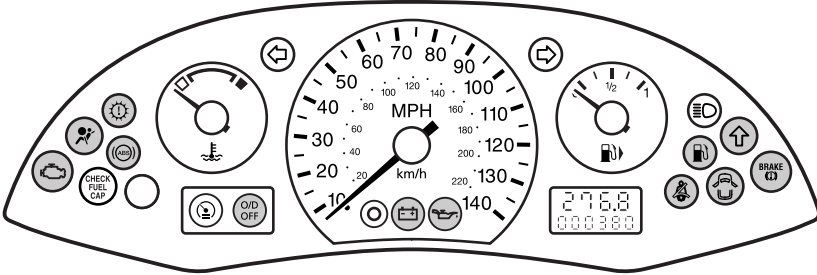
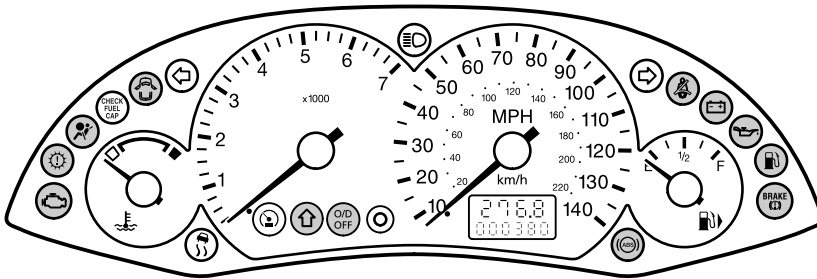
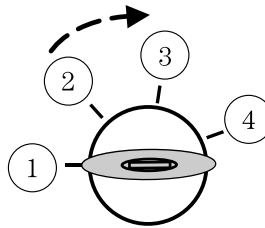

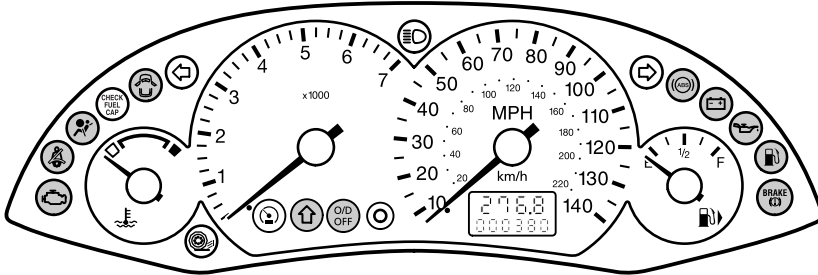

Make sure the corresponding lights illuminate or illuminate briefly. If a light fails to illuminate, have the vehicle serviced.

- If the driver's safety belt is fastened, the  light may not illuminate.

Starting the engine

1. Turn the key to 3 (ON) without turning the key to 4 (START).
2. Turn the key to 4 (START), then release the key as soon as the engine starts. Excessive cranking could damage the starter.

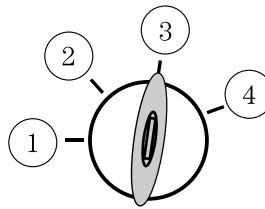

Note: If the engine does not start within five seconds on the first try, turn the key to OFF, wait 10 seconds and try again. If the engine still fails to start, press the accelerator to the floor and try again; this will allow the engine to crank with the fuel shut off in case the engine is flooded with fuel.

Using the engine block heater (if equipped)

An engine block heater warms the engine coolant which aids in starting and heater/defroster performance. Use of an engine block heater is strongly recommended if you live in a region where temperatures reach -23°C (-10°F) or below. For best results, plug the heater in at least three hours before starting the vehicle. The heater can be plugged in the night before starting the vehicle.



To reduce the risk of electrical shock, do not use your heater with ungrounded electrical systems or two-pronged (cheater) adapters.

Driving

Guarding against exhaust fumes

Carbon monoxide is present in exhaust fumes. Take precautions to avoid its dangerous effects.



If you smell exhaust fumes inside your vehicle, have your dealer inspect your vehicle immediately. Do not drive if you smell exhaust fumes.

Important ventilating information

If the engine is idling while the vehicle is stopped for a long period of time, open the windows at least 2.5 cm (one inch) or adjust the heating or air conditioning to bring in fresh air.

BRAKES

Occasional brake noise is normal. If a metal-to-metal, continuous grinding or continuous squeal sound is present, the brake linings may be worn-out and should be inspected by a qualified service technician. If the vehicle has continuous vibration or shudder in the steering wheel while braking, the vehicle should be inspected by a qualified service technician.

Refer to *Brake system warning light* in the *Instrument Cluster* chapter for information on the brake system warning light.



Under normal operating conditions, brake dust may accumulate on the wheels. Some brake dust is inevitable as brakes wear and does not contribute to brake noise. The use of modern friction materials with emphasis on improved performance and environmental considerations can lead to more dust than in the past. Brake dust can be cleaned by weekly washing with soapy water and a soft sponge. Heavier deposits can be removed with Motorcraft Wheel and Tire Cleaner (ZC-37-A).

Four-wheel anti-lock brake system (ABS) (if equipped)

Your vehicle may be equipped with an Anti-lock Braking System (ABS). This system helps you maintain steering control during emergency stops by keeping the brakes from locking. Noise from the ABS pump motor and brake pedal pulsation may be observed during ABS braking; any pulsation or mechanical noise you may feel or hear is normal.

Using ABS

When hard braking is required, apply continuous force on the brake pedal; do not pump the brake pedal since this will reduce the

effectiveness of the ABS and will increase your vehicle's stopping distance. The ABS will be activated immediately, allowing you to retain full steering control during hard braking and on slippery surfaces. However, the ABS does not decrease stopping distance.

ABS warning lamp

The ABS lamp in the instrument cluster momentarily illuminates when the ignition is turned on. If the light does not illuminate during start up, remains on or flashes, the ABS may be disabled and may need to be serviced



Even when the ABS is disabled, normal braking is still effective. (If your BRAKE warning lamp illuminates with the parking brake released, have your brake system serviced immediately.)



Parking brake

To set the parking brake (1), pull the parking brake handle up as far as possible.

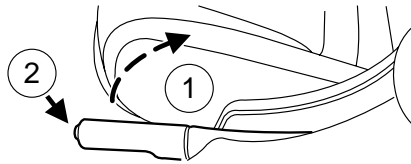

The BRAKE warning lamp will illuminate and will remain illuminated until the parking brake is released.



To release, press and hold the button (2), pull the handle up slightly, then push the handle down.



Always set the parking brake fully and make sure that the gearshift is securely latched in P (Park) (automatic transmission) or in 1 (First) (manual transmission).



If the parking brake is fully released, but the brake warning lamp remains illuminated, the brakes may not be working properly. See your dealer or a qualified service technician.

Driving

TRACTION CONTROL™ (IF EQUIPPED)

Your vehicle may be equipped with a Traction Control™ system. This system helps you maintain the stability and steerability of your vehicle, especially on slippery road surfaces such as snow- or ice-covered roads and gravel roads. The system will allow your vehicle to make better use of available traction in these conditions.

During Traction Control™ operation, the traction control active light will illuminate, you may hear an electric motor type of sound coming from the engine compartment and the engine will not “rev-up” when you push further on the accelerator. This is normal system behavior and should be no reason for concern.



At speeds below 85 km/h (53 mph), both the engine and the brake system will be used to control wheel spin; at speeds above 85 km/h (53 mph), only engine torque reduction is used. When the Traction Control™ system is switched off, the braking system will still be used to control wheel spin at speeds below 40 km/h (25 mph).

The Traction Control™ switch is located on the center console, by the gearshift lever. The Traction Control™ system will automatically turn on every time the ignition is turned off and on.

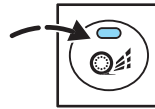

If you should become stuck in snow or ice or on a very slippery road surface, try switching the Traction Control™ system off by pressing the switch. This may allow excess wheel spin to “dig” the vehicle out and enable a successful “rocking” maneuver. If you want to turn off the Traction Control™ system be aware that, for safety reasons, the switch must be pressed and held for at least one second before the system is turned off.

If a system fault is detected, the traction control active light will illuminate, the Traction Control™ button will not turn the system on or off and your vehicle should be serviced.

STEERING

To prevent damage to the power steering system:

- Never hold the steering wheel at its furthest turning points (until it stops) for more than a few seconds when the engine is running.
- Do not operate the vehicle with a low power steering pump fluid level (below the MIN mark on the reservoir).

If the power steering system breaks down (or if the engine is turned off), you can steer the vehicle manually, but it takes more effort.

If the steering wanders or pulls, check for:

- an improperly inflated tire
- uneven tire wear
- loose or worn suspension components
- loose or worn steering components
- improper steering alignment

A high crown in the road or high crosswinds may also make the steering seem to wander/pull.

AUTOMATIC TRANSMISSION OPERATION (IF EQUIPPED)

Brake-shift interlock

This vehicle is equipped with a brake-shift interlock feature that prevents the gearshift lever from being moved from P (Park) when the ignition is in the ON position unless the brake pedal is depressed.

If you cannot move the gearshift lever out of P (Park) with ignition in the ON position and the brake pedal depressed:

1. Apply the parking brake, turn ignition key to LOCK, then remove the key.



When the key is in the ignition and in the OFF position, the automatic transmission shift lever can be moved from the P (Park) position without the brake pedal depressed. To avoid unwanted vehicle movement, always set the parking brake.

Driving

2. Using a screwdriver (or similar tool), remove the protective cover to the interlock access hole on the console. Insert the key to release the interlock.

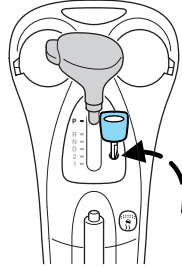

3. Apply the parking brake, then shift to N (Neutral).

4. Start the vehicle.

If it is necessary to use the above procedure to move the gearshift lever, it is possible that a fuse has blown or the vehicle's brakelamps are not operating properly. Refer to *Fuses and relays* in the *Roadside Emergencies* chapter.



Do not drive your vehicle until you verify that the brakelamps are working.



Always set the parking brake fully and make sure the gearshift is latched in P (Park). Turn the ignition to the LOCK position and remove the key whenever you leave your vehicle.



If the parking brake is fully released, but the brake warning lamp remains illuminated, the brakes may not be working properly. See your dealer or a qualified service technician.

Understanding the gearshift positions of the 4-speed automatic transaxle

This vehicle is equipped with an adaptive Transmission Shift Strategy. Adaptive Shift Strategy offers the optimal transmission operation and shift quality. When the vehicle's battery has been disconnected for any type of service or repair, the transmission will need to relearn the normal shift strategy parameters, much like having to reset your radio stations when your vehicle battery has been disconnected. The Adaptive Transmission Strategy allows the transmission to relearn these operating parameters. This learning process could take several transmission

upshifts and downshifts; during this learning process, slightly firmer shifts may occur. After this learning process, normal shift feel and shift scheduling will resume.

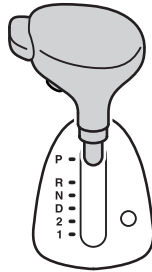

P (Park)

This position locks the transaxle and prevents the front wheels from turning.

To put your vehicle in gear:

- Start the engine
- Depress the brake pedal
- Move the gearshift lever into the desired gear

To put your vehicle in P (Park):

- Come to a complete stop
- Move the gearshift lever and securely latch it in P (Park)



Always set the parking brake fully and make sure the gearshift is latched in P (Park). Turn the ignition to the LOCK position and remove the key whenever you leave your vehicle.

R (Reverse)

With the gearshift lever in R (Reverse), the vehicle will move backward. Always come to a complete stop before shifting into and out of R (Reverse).

N (Neutral)

With the gearshift lever in N (Neutral), the vehicle can be started and is free to roll. Hold the brake pedal down while in this position.

Driving

D (Overdrive)

The normal driving position for the best fuel economy; transaxle operates in gears one through four. D (Overdrive) can be deactivated by pressing the transaxle control switch on the end of the gearshift lever. This will illuminate the O/D OFF lamp and activate Drive.

Drive (not shown)

Drive is activated when the transaxle control switch is pressed.

- This position allows for all forward gears except overdrive.
- O/D OFF lamp is illuminated.
- Provides engine braking.
- Use when driving conditions cause excessive shifting from O/D to other gears. Examples: city traffic, hilly terrain, heavy loads, trailer towing and when engine braking is required.
- To return to O/D (overdrive mode), press the transaxle control switch. The O/D OFF lamp will not be illuminated.
- O/D (Overdrive) is automatically returned each time the key is turned off.

2 (Second)

This position allows for second gear only.

- Provides engine braking.
- Use to start-up on slippery roads.
- To return to D (Overdrive), move the gearshift lever into the D (Overdrive) position.
- Selecting 2 (Second) at higher speeds will cause the transaxle to downshift to second gear at the appropriate vehicle speed.

1 (First)

- Provides maximum engine braking.
- Allows upshifts by moving gearshift lever.
- Will not downshift into 1 (First) at high speeds; allows for 1 (First) when vehicle reaches slower speeds.

If your vehicle gets stuck in mud or snow

If your vehicle gets stuck in mud or snow, it may be rocked out by shifting from forward and reverse gears, stopping between shifts in a steady pattern. Press lightly on the accelerator in each gear.

If necessary, try turning the Traction Control[™] system off. This will allow the wheels to spin, which may help to free your stuck vehicle. For more information, refer to *Traction Control[™] (if equipped)* in this chapter.

Do not rock the vehicle if the engine is not at normal operating temperature or damage to the transmission may occur.

Do not rock the vehicle for more than a minute or damage to the transmission and tires may occur, or the engine may overheat.

MANUAL TRANSMISSION OPERATION (IF EQUIPPED)

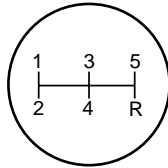

Using the clutch

The manual transaxle has a starter interlock that prevents cranking the engine unless the clutch pedal is fully depressed.

To start the vehicle:

1. Make sure the parking brake is fully set.
2. Press the clutch pedal to the floor, then put the gearshift lever in the neutral position.
3. Start the engine, then press the brake pedal and release the parking brake.
4. Move the gearshift lever to the desired gear, then slowly release the clutch pedal while slowly pressing on the accelerator.

Do not drive with your foot resting on the clutch pedal or use the clutch pedal to hold your vehicle at a standstill while waiting on a hill. These actions will reduce the life of the clutch.

Driving

Recommended shift speeds

Upshift according to the following chart:

Recommended upshifts (for best fuel economy) when accelerating	
5-speed manual transaxle	
Shift from:	
1 - 2	14 mph (23 km/h)
2 - 3	25 mph (40 km/h)
3 - 4	36 mph (58 km/h)
4 - 5	45 mph (72 km/h)

Reverse

Make sure that your vehicle is at a complete stop before you shift into R (Reverse). Failure to do so may damage the transaxle.

- **If your vehicle is equipped with the SPI engine**, move the gearshift lever fully to the right, then back into R (Reverse).
- **If your vehicle is equipped with the Zetec engine or 2.3L engine**, you must lift the locking ring (1), then move the gearshift lever fully to the right, then back into R (Reverse) (2).

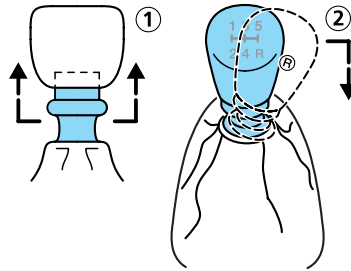

Parking your vehicle

1. Apply the brake and shift into the neutral position.
2. Fully apply the parking brake, then shift into 1 (First).
3. Turn the ignition off.



Do not park your vehicle in Neutral, it may move unexpectedly and injure someone. Use 1 (First) gear and set the parking brake fully.

Removing the key

Turn the ignition to position 1 (LOCK) and remove the key.

120

2004 Focus (foc)
Owners Guide (post-2002-fmt)
USA English (fus)

DRIVING THROUGH WATER

If driving through deep or standing water is unavoidable, proceed very slowly especially if the depth is not known. Never drive through water that is higher than the bottom of the hubs (for trucks) or the bottom of the wheel rims (for cars). Traction or brake capability may be limited and your vehicle may stall. Water may also enter your engine's air intake and severely damage your engine.

Once through the water, always dry the brakes by moving your vehicle slowly while applying light pressure on the brake pedal. Wet brakes do not stop the vehicle as quickly as dry brakes. **Driving through deep water where the transmission vent tube is submerged may allow water into the transmission and cause internal transmission damage.**

VEHICLE LOADING – WITH AND WITHOUT A TRAILER

This section will guide you in the proper loading of your vehicle and/or trailer, to keep your loaded vehicle weight within its design rating capability, with or without a trailer. Properly loading your vehicle will provide maximum return of vehicle design performance. Before loading your vehicle, familiarize yourself with the following terms for determining your vehicle's weight ratings, with or without a trailer, from the vehicle's Safety Certification Label and Tire Label:

Base Curb Weight – is the weight of the vehicle including a full tank of fuel and all standard equipment. It does not include passengers, cargo, or optional equipment.

Vehicle Curb Weight – is the weight of your new vehicle when you picked it up from your dealer plus any aftermarket equipment.

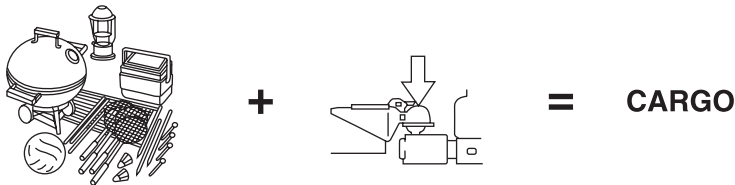

Cargo Weight – includes all weight added to the Base Curb Weight, including cargo and optional equipment. When towing, trailer tongue load or king pin weight is also part of cargo weight.

GAW (Gross Axle Weight) – is the total weight placed on each axle (front and rear) – including vehicle curb weight and all payload.

Driving

GAWR (Gross Axle Weight Rating) – is the maximum allowable weight that can be carried by a single axle (front or rear). **These numbers are shown on the Safety Compliance Certification Label located on the driver's door or door pillar. The total load on each axle must never exceed its GAWR.**

 Exceeding the Safety Certification Label axle weight rating limits could result in substandard vehicle handling, performance, engine, transmission and/or structural damage, serious damage to the vehicle, loss of control and personal injury.

Note: For trailer towing information refer to *Trailer towing* found in this chapter or the *RV and Trailer Towing Guide* provided by your dealership.

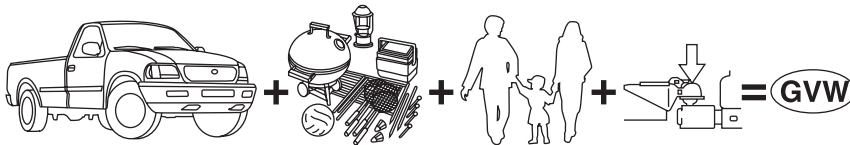

GVW (Gross Vehicle Weight) – is the Vehicle Curb Weight + cargo + passengers.

GVWR (Gross Vehicle Weight Rating) – is the maximum allowable weight of the fully loaded vehicle (including all options, equipment, passengers and cargo). **The GVWR is shown on the Safety Compliance Certification Label located on the driver's door or door pillar. The GVW must never exceed the GVWR.**

Sample Safety Compliance Certification Label		
<i>(Refer to actual label on your vehicle)</i>		
Front GAWR	GVWR	Rear GAWR
MFD. BY FORD MOTOR CO. IN U.S.A.		
DATE: 06/95	GVWR: 6250 LB/2834 KG	
FRONT GAWR: 3450 LB 1584KG	WITH TIRES RIMS	REAR GAWR: 3777 LB 1713KG WITH TIRES RIMS
P265/75R15SL 15X7.5J AT 30 PSI COLD		P265/75R15SL 15X7.5J AT 30 PSI COLD
THIS VEHICLE CONFORMS TO ALL APPLICABLE FEDERAL MOTOR VEHICLE SAFETY STANDARDS IN EFFECT ON THE DATE OF MANUFACTURE SHOWN ABOVE.		
XXXXXXXXXXXX		
VIN: 1FTEX14H 0 SKB 00000		F0018 TC183
TYPE: XXXXXXXXXXXXXXX		
		
EXT PNT: XXXXXXX XXXXXX		
WD	TYPE-GVW	DOO
155	REM	HB
	TRANS	AXLE
	E	TAPE
		SPRINGS
		M4

Driving

 Exceeding the Safety Certification Label axle weight rating limits could result in substandard vehicle handling, performance, engine, transmission and/or structural damage, serious damage to the vehicle, loss of control and personal injury.

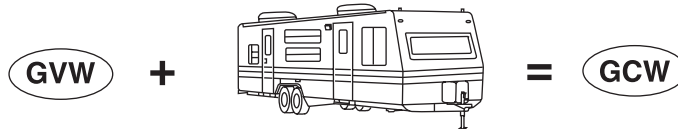

GCW (Gross Combined Weight) – is the weight of the loaded vehicle (GVW) plus the weight of the fully loaded trailer.

GCWR (Gross Combined Weight Rating) – is the maximum allowable weight of the vehicle and the loaded trailer – including all cargo and passengers – that the vehicle can handle without risking damage. (Important: The towing vehicle's braking system is rated for operation at GVWR, not at GCWR. Separate functional brakes should be used for safe control of towed vehicles and for trailers where the GCW of the towing vehicle plus the trailer exceed the GVWR of the towing vehicle. **The GCW must never exceed the GCWR.**

Maximum Loaded Trailer Weight – is the highest possible weight of a fully loaded trailer the vehicle can tow. It assumes a vehicle with only mandatory options, no cargo (internal or external), a tongue load of 10–15% (conventional trailer) or king pin weight of 15–25% (fifth wheel trailer), and driver only (150 lbs [68 kg]). **Consult your dealership (or the *RV and Trailer Towing Guide* provided by your dealership) for more detailed information.**

Tongue Load or Fifth Wheel King Pin Weight – refers to the amount of the weight that a trailer pushes down on a trailer hitch.

Examples: For a 5,000 lbs. (2,268 kg) conventional trailer, multiply 5,000 by 0.10 and 0.15 to obtain a proper tongue load range of 500 to 750 lbs. (227 to 340 kg). For an 11,500 lbs. (5,216 kg) fifth wheel trailer, multiply by 0.15 and 0.25 to obtain a proper king pin load range of 1,725 to 2,875 lbs. (782 to 1,304 kg)

 Do not exceed the GVWR or the GAWR specified on the certification label.

Driving

 Do not use replacement tires with lower load carrying capacities than the originals because they may lower the vehicle's GVWR and GAWR limitations. Replacement tires with a higher limit than the originals do not increase the GVWR and GAWR limitations.

 Exceeding any vehicle weight rating limitation could result in serious damage to the vehicle and/or personal injury.

TRAILER TOWING

Your vehicle is capable of towing a trailer up to 454 kg (1,000 lbs.) gross trailer weight with a maximum tongue load of 45 kg (100 lbs.). Do not tow a trailer until your vehicle has been driven at least 800 km (500 miles).

Towing a trailer places an additional load on your vehicle's engine, transaxle, brakes, tires and suspension. Inspect these components carefully after towing.

 Do not exceed the GVWR or the GAWR specified on the certification label.

 Towing trailers beyond the maximum recommended gross trailer weight exceeds the limit of the vehicle and could result in engine damage, transaxle damage, structural damage, increased risk of loss of vehicle control, vehicle rollover and/or serious personal injury.

Preparing to tow

Use the proper equipment for towing a trailer and make sure it is properly attached to your vehicle. See your dealer or a reliable trailer dealer if you require assistance.

Hitches

Do not use hitches that clamp onto the vehicle bumper. Use a load carrying hitch. You must distribute the load in your trailer so that 10–15% of the total weight of the trailer is on the tongue.

Safety chains

Always connect the trailer's safety chains to the frame or hook retainers of the vehicle hitch. To connect the trailer's safety chains, cross the chains under the trailer tongue and allow slack for turning corners.

Driving

If you use a rental trailer, follow the instructions that the rental agency gives to you.

Do not attach safety chains to the bumper.

Trailer brakes

Electric brakes and manual, automatic or surge-type trailer brakes are safe if installed properly and adjusted to the manufacturer's specifications. The trailer brakes must meet local and Federal regulations.



Do not connect a trailer's hydraulic brake system directly to your vehicle's brake system. Your vehicle may not have enough braking power and your chances of having a collision greatly increase.

The braking system of the tow vehicle is rated for operation at the GVWR not GCWR.

Trailer lamps

Trailer lamps are required on most towed vehicles. Make sure all running lights, brake lights, turn signals and hazard lights are working. See your dealer or trailer rental agency for proper instructions and equipment for hooking up trailer lamps.

Driving while you tow

When towing a trailer:

- Turn off the speed control. The speed control may shut off automatically when you are towing on long, steep grades.
- Consult your local motor vehicle speed regulations for towing a trailer.
- To eliminate excessive shifting, use a lower gear. This will also assist in transaxle cooling.
- Anticipate stops and brake gradually.
- Do not exceed the GCWR rating or transaxle damage may occur.

Servicing after towing

If you tow a trailer for long distances, your vehicle will require more frequent service intervals. Refer to your *Scheduled Maintenance Guide* for more information.

Trailer towing tips

- Practice turning, stopping and backing up before starting on a trip to get the feel of the vehicle trailer combination. When turning, make wider turns so the trailer wheels will clear curbs and other obstacles.

Driving

- Allow more distance for stopping with a trailer attached.
- If you are driving down a long or steep hill, shift to a lower gear. Do not apply the brakes continuously, as they may overheat and become less effective.
- The trailer tongue weight should be 10–15% of the loaded trailer weight.
- After you have traveled 80 km (50 miles), thoroughly check your hitch, electrical connections and trailer wheel lug nuts.
- To aid in engine/transmission cooling and A/C efficiency during hot weather while stopped in traffic, place the gearshift lever in P (Park).
- Vehicles with trailers should not be parked on a grade. If you must park on a grade, place wheel chocks under the trailer's wheels.

RECREATIONAL TOWING

Follow these guidelines for your specific powertrain combination to tow your vehicle with all four wheels on the ground (such as behind a recreational vehicle).

These guidelines are designed to ensure that your transmission is not damaged due to insufficient lubrication.

All Front Wheel Drive (FWD) vehicles:

If your vehicle is equipped with an automatic transaxle, you cannot tow the vehicle with the front drive wheels on the ground. It is recommended to tow your vehicle with the drive wheels on a dolly or two wheel car hauling trailer.

In case of a roadside emergency with a disabled vehicle (without access to wheel dollies, car hauling trailer or flatbed transport vehicle) your vehicle can be flat towed (all wheels on the ground) under the following conditions:

- Place the transmission in N (Neutral).
- Maximum speed is 56 km/h (35 mph).
- Maximum distance is 80 km (50 miles).

If your vehicle is equipped with a manual transaxle, and in the case of a roadside emergency with a disabled vehicle (without access to wheel dollies, car hauling trailer or flatbed transport vehicle) your vehicle can be flat towed (all wheels on the ground) under the following conditions:

- Place the transmission in N (Neutral).
- Maximum distance is unlimited.

Roadside Emergencies

GETTING ROADSIDE ASSISTANCE

To fully assist you should you have a vehicle concern, Ford Motor Company offers a complimentary roadside assistance program. This program is separate from the New Vehicle Limited Warranty. The service is available:

- 24-hours, seven days a week
- for the New Vehicle Limited Warranty period of three years or 60,000 km (36,000 miles), whichever occurs first on Ford and Mercury vehicles, and four years or 80,000 km (50,000 miles) on Lincoln vehicles.

Roadside assistance will cover:

- changing a flat tire
- jump-starts
- lock-out assistance
- limited fuel delivery
- towing of your disabled vehicle to the nearest Ford Motor Company dealership, or your selling dealer if within 56.3 km (35 miles) of the nearest Ford Motor Company dealership (one tow per disablement). Even non-warranty related tows, like accidents or getting stuck in the mud or snow, are covered (some exclusions apply, such as impound towing or repossession).

Canadian customers refer to your Owner Information Guide for information on:

- coverage period
- exact fuel amounts
- towing of your disabled vehicle
- emergency travel expense reimbursement
- travel planning benefits

USING ROADSIDE ASSISTANCE

Complete the roadside assistance identification card and place it in your wallet for quick reference. In the United States, this card is found in the Owner Guide portfolio in the glove compartment in Ford vehicles and is mailed to you if you own a Mercury or Lincoln. In Canada, the card is found in the Owner Information Guide in the glove compartment.

U.S. Ford or Mercury vehicle customers who require roadside assistance, call 1-800-241-3673; Lincoln vehicle customers call 1-800-521-4140.

Roadside Emergencies

Canadian customers who require roadside assistance, call 1-800-665-2006.

If you need to arrange roadside assistance for yourself, Ford Motor Company will reimburse a reasonable amount. To obtain reimbursement information, U.S. Ford or Mercury vehicles customers call 1-800-241-3673; Lincoln vehicle customers call 1-800-521-4140.

Canadian customers who need to obtain reimbursement information, call 1-800-665-2006.

ROADSIDE COVERAGE BEYOND BASIC WARRANTY

In the United States, you may purchase additional roadside assistance coverage beyond this period through the Ford Auto Club by contacting your Ford or Lincoln Mercury dealer.

Similarly in Canada, for uninterrupted Roadside Assistance coverage, you may purchase extended coverage prior to your Basic Warranty's Roadside Assistance expiring. For more information and enrollment, contact 1-877-294-2582 or visit our website at www.ford.ca.

HAZARD FLASHER CONTROL

The hazard flasher is located on the instrument panel by the radio. The hazard flashers will operate when the ignition is off.



Push in the flasher control and all front and rear direction signals will flash. Press the flasher control again to turn them off. Use it when your vehicle is disabled and is creating a safety hazard for other motorists.

Note: With extended use, the flasher may run down your battery.

FUEL PUMP SHUT-OFF SWITCH

This device stops the electric fuel pump from sending fuel to the engine when your vehicle has had a substantial jolt.

After an accident, if the engine cranks but does not start, this switch may have been activated.

Roadside Emergencies

This switch is located in the front passenger's footwell, behind the kick panel access cover.

To reset the switch:

1. Turn the ignition OFF.
2. Check the fuel system for leaks.
3. If no leaks are apparent, reset the switch by pushing in on the reset button.
4. Turn the ignition ON.
5. Wait a few seconds and return the key to OFF.
6. Make another check of leaks.

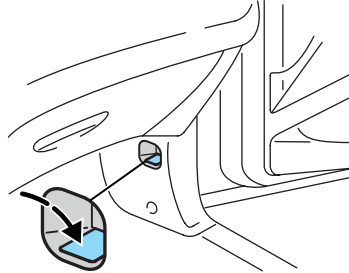

FUSES AND RELAYS

Fuses

If electrical components in the vehicle are not working, a fuse may have blown. Blown fuses are identified by a broken wire within the fuse. Check the appropriate fuses before replacing any electrical components.

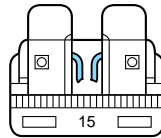

Note: Always replace a fuse with one that has the specified amperage rating. Using a fuse with a higher amperage rating can cause severe wire damage and could start a fire.

Roadside Emergencies

Standard fuse amperage rating and color

COLOR					
Fuse rating	Mini fuses	Standard fuses	Maxi fuses	Cartridge maxi fuses	Fuse link cartridge
2A	Grey	Grey	—	—	—
3A	Violet	Violet	—	—	—
4A	Pink	Pink	—	—	—
5A	Tan	Tan	—	—	—
7.5A	Brown	Brown	—	—	—
10A	Red	Red	—	—	—
15A	Blue	Blue	—	—	—
20A	Yellow	Yellow	Yellow	Blue	Blue
25A	Natural	Natural	—	—	—
30A	Green	Green	Green	Pink	Pink
40A	—	—	Orange	Green	Green
50A	—	—	Red	Red	Red
60A	—	—	Blue	—	Yellow
70A	—	—	Tan	—	Brown
80A	—	—	Natural	—	Black

Passenger compartment fuse panel

The fuse panel is located below and to the left of the steering wheel by the brake pedal. Remove the panel cover to access the fuses.

To remove a fuse use the fuse puller tool provided on the fuse panel cover.

Roadside Emergencies

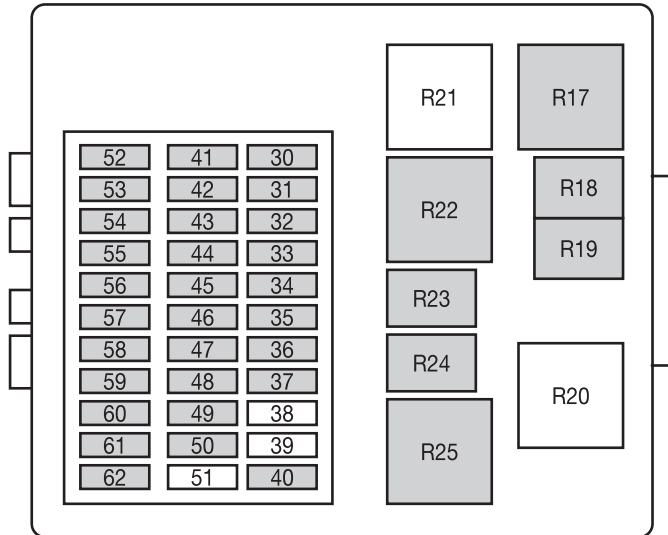

The fuses are coded as follows.

Fuse/Relay Location	Fuse Amp Rating	Passenger Compartment Fuse Panel Description
R17	—	Starter relay
R18	—	Rear intermittent relay
R19	—	Front wiper intermittent relay
R20	—	Not used
R21	—	Not used
R22	—	Decklid/Liftgate release relay
R23	—	Horn relay
R24	—	Battery saver relay
R25	—	Rear defrost relay
30	10A	Light switch
31	15A	Radio
32	15A	Turn signal

Roadside Emergencies

Fuse/Relay Location	Fuse Amp Rating	Passenger Compartment Fuse Panel Description
33	20A	Horn, Power seats (SVT only)
34	20A	Power sunroof
35	7.5A	Interior lamps, Power mirrors
36	7.5A	A/C switch, Hazard flasher, Instrument cluster
37	25A	Decklid/Liftgate release
38	—	Not used
39	—	Not used
40	10A	Backup lamps (automatic transaxle)
41	7.5A	Radio and cluster (accessory)
42	15A	Stop lamps
43	15A	Rear wiper
44	20A	Fog lamps
45	7.5A	Recirculated air, Air conditioning
46	7.5A	Anti-lock Brake System (ABS)
47	20A	Cigar lighter, Rear power point (SVT only)
48	10A	Data link connector
49	25A	Rear defroster
50	7.5A	Heated mirror, Heated backlite indicator
51	—	Not used
52	15A	Heated seats
53	10A	Backup lamps (manual transaxle)
54	25A	Rear power windows
55	25A	Front power windows
56	20A	Front wipers
57	7.5A	Position and side lights (right)
58	7.5A	Position and side lights (left)
59	7.5A	Light switch (headlamps)
60	7.5A	Air bag module

132

2004 Focus (foc)
 Owners Guide (post-2002-fmt)
 USA English (fus)

Roadside Emergencies

Fuse/Relay Location	Fuse Amp Rating	Passenger Compartment Fuse Panel Description
61	7.5A	PATS modules, Instrument cluster
62	7.5A	License plate lamp
63	20A	Power locks (GEM)

Fuse 63 is located on the back of the fuse panel. See your dealer or a certified technician for service of this fuse.

Power distribution box

The power distribution box is located in the engine compartment. The power distribution box contains high-current fuses that protect your vehicle's main electrical systems from overloads.



Always disconnect the battery before servicing high current fuses.

Always replace the cover to the power distribution box before reconnecting the battery or refilling fluid reservoirs

If the battery has been disconnected and reconnected, refer to the *Battery* section of the *Maintenance and specifications* chapter.

Roadside Emergencies

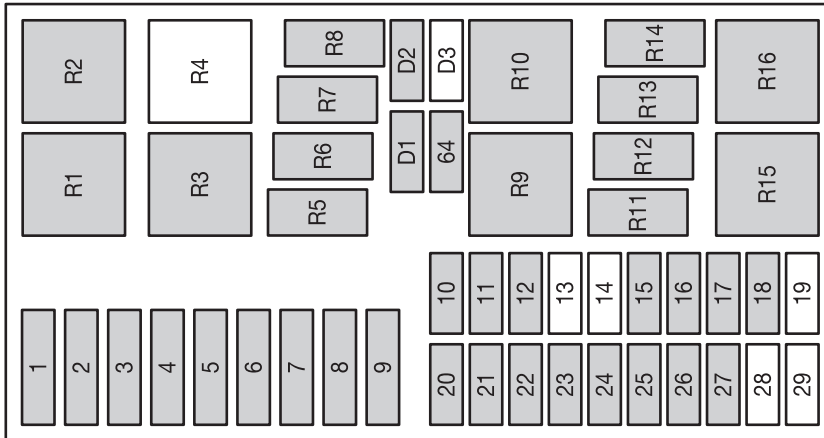

To remove a fuse, use the fuse puller tool provided on the power distribution box cover.

The high-current fuses are coded as follows:

Fuse/Relay Location	Fuse Amp Rating	Power Distribution Box Description
1	40A	Main power supply to electrical system
2	30A	Engine cooling fan (A/C) 2nd fuse
3	30A	Cooling fan (2.0L engine only)
4	30A	Air pump motor
5	30A	Cooling fan 2 (2.0L engine only)
6	50A	Engine cooling fan (A/C) 1st fuse
7	40A	Main power supply to electrical system
8	30A	Ignition switch, Starter
9	20A	Engine management

Roadside Emergencies

Fuse/Relay Location	Fuse Amp Rating	Power Distribution Box Description
10	10A (2.0L engine only)	Battery voltage sensor
	1A (2.3L engine only)	
11	30A	Anti-lock Brake System (ABS)
12	15A	Fuel pump
13	—	Not used
14	—	Not used
15	10A	A/C clutch solenoid
16	10A	Low beam (left side - conventional headlamps)
	15A	Low beam (left side - HID headlamps)
17	10A	Low beam (right side - conventional headlamps)
	15A	Low beam (right side - HID headlamps)
18	10A (2.0L engine only)	Heated oxygen sensors
	15A (2.3L engine only)	
19	—	Not used
20	10A	Engine module
21	20A	ABS
22	20A	Low beam (DRL)
23	—	Not used
24	30A	Subwoofer
25	—	Not used

Roadside Emergencies

Fuse/Relay Location	Fuse Amp Rating	Power Distribution Box Description
26	—	Not used
27	15A	High beams (right and left)
28	—	Not used
29	10A	Cooling fan (2.3L engine only)
64	40A	Heater blower motor
R1	—	Ignition relay
R2	—	Air pump motor relay (2.3L engine only)
R3	—	Cooling fan (Run-on fan) relay (2.3L engine only)
R4	—	Not used
R5	—	High beams relay
R6	—	Low beams relay
R7	—	Fuel pump relay
R8	—	Engine management relay
R9	—	Cooling fan relay (2.0L engine only)
R10	—	Cooling fan 2 relay (2.0L engine only)
R11	—	Air conditioning relay
R12	—	Daytime Running Lamps (DRL) relay
R13	—	Fog lamps relay
R14	—	HID lamps (SVT only)
R15	—	Cooling fan high speed (A/C only) relay (2.0L engine only)
R16	—	Cooling fan low speed relay
D1	—	PCM diode
D2	—	Cooling fan diode
D3	—	A/C clutch diode

Roadside Emergencies

CHANGING A FLAT TIRE

If you get a flat tire while driving:

- do not brake heavily.
- gradually decrease the vehicle's speed.
- hold the steering wheel firmly.
- slowly move to a safe place on the side of the road.



The use of tire sealants may damage your tires.

Temporary spare tire information

The temporary spare tire for your vehicle is labeled as such. It is smaller than a regular tire and is designed for emergency use only. Replace the temporary spare tire with a full-size tire as soon as possible.



If you use the temporary spare tire continuously or do not follow these precautions, the tire could fail, causing you to lose control of the vehicle, possibly injuring yourself or others.

When driving with the temporary spare tire **do not:**

- use more than one temporary spare tire at a time
- exceed 80 km/h (50 mph)
- load the vehicle beyond maximum vehicle load rating listed on the Safety Compliance Label
- tow a trailer
- use tire chains
- drive through an automatic car wash, because of the vehicle's reduced ground clearance
- try to repair the temporary spare tire or remove it from its wheel
- use the wheel for any other type of vehicle

Use of a temporary spare tire at any one wheel location can lead to impairment of the following:

- handling, stability and braking performance
- comfort and noise
- ground clearance and parking at curbs
- Winter driving capability

Roadside Emergencies

Dissimilar spare tire/wheel information



Failure to follow these guidelines could result in an increased risk of loss of vehicle control, injury or death.

Your vehicle may be equipped with a dissimilar spare tire/wheel. A dissimilar spare tire/wheel is defined as a spare tire and/or wheel that is different in brand, size or appearance from the road tires and wheels. If you have a dissimilar spare tire/wheel, then it is intended for temporary use only. This means that if you need to use it, you should replace it as soon as possible with a road tire/wheel that is the same size and type as the road tires and wheels that were originally provided by Ford. If the dissimilar spare tire or wheel is damaged, it should be replaced rather than repaired.

When driving with the dissimilar spare tire/wheel, **do not:**

- Exceed 70 mph (113 km/h)
- Use more than one dissimilar spare tire/wheel at a time
- Use commercial car washing equipment
- Use snow chains on the end of the vehicle with the dissimilar spare tire/wheel

The usage of a dissimilar spare tire/wheel can lead to impairment of the following:

- Handling, stability and braking performance
- Comfort and noise
- Ground clearance and parking at curbs
- Winter weather driving capability
- Wet weather driving capability
- All-Wheel Driving Capability (if applicable)
- Load Leveling Adjustment (if applicable)

When driving with the dissimilar spare tire/wheel additional caution should be given to:

- Towing a trailer
- Driving vehicles equipped with a camper body
- Driving vehicles with a load on the cargo rack

Drive cautiously when using a dissimilar spare tire/wheel and seek service as soon as possible.

Roadside Emergencies

Tire change procedure

1. Park on a level surface, activate hazard flashers and set the parking brake.

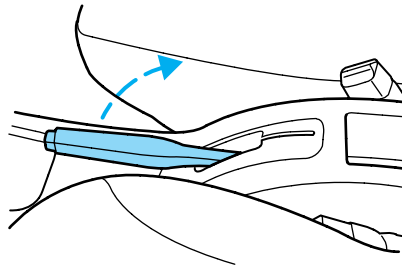

 When one of the front wheels is off the ground, the transaxle alone will not prevent the vehicle from moving or slipping off the jack, even if the vehicle is in P (Park) (automatic transaxle) or R (Reverse) (manual transaxle).

 To help prevent the vehicle from moving when you change a tire, be sure the parking brake is set, then block (in both directions) the wheel that is diagonally opposite (other side and end of the vehicle) to the tire being changed.

 If the vehicle slips off the jack, you or someone else could be seriously injured.

2. Place gearshift lever in P (Park) (automatic transaxle) or R (Reverse) (manual transaxle), turn engine OFF, and block the diagonally opposite wheel.

3. Remove the spare tire and jack by turning their tie-down bolts counterclockwise. The lug wrench is located in a bag next to the spare tire (coupe and 5-door models) or on top of the spare tire (sedan and wagon models).

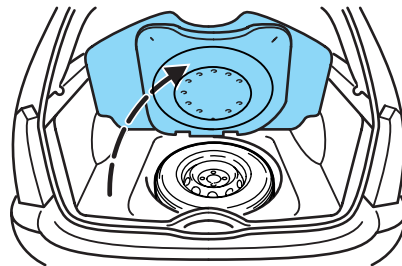

Roadside Emergencies

4. On coupe models, unsnap and remove the access door (if equipped) on the lower rocker molding (SVT only) to access the proper jacking points.

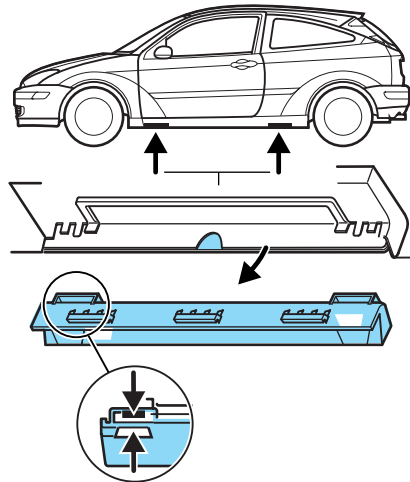

5. Loosen each wheel lug nut one-half turn counterclockwise but do not remove them until the wheel is raised off the ground.

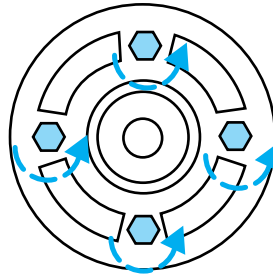

Roadside Emergencies

6. The vehicle jacking points are depicted on the yellow warning label on the jack shown here. Depending on which tire is to be changed, locate the jack at the half-moon cutout located approximately six inches (15 cm) from the front wheel opening (1) or approximately 15 inches (38 cm) from the rear wheel opening (2).

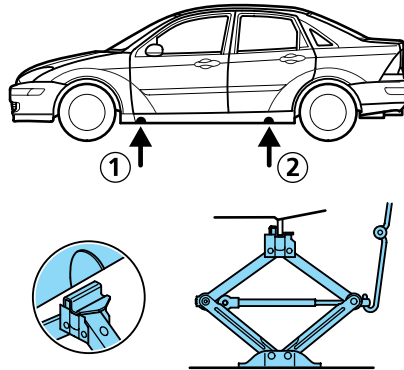

Jack at the specified locations to avoid damage to the vehicle.

7. Remove the lug nuts with the lug wrench.
8. Replace the flat tire with the spare tire, making sure the valve stem is facing outward. Reinstall the lug nuts until the wheel is snug against the hub. Do not fully tighten the lug nuts until the wheel has been lowered.
9. Lower the wheel by turning the jack handle counterclockwise.
10. Remove the jack and fully tighten the lug nuts in the order shown.

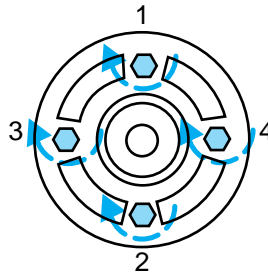

11. Put flat tire, jack and lug wrench away. Make sure the jack is fastened so it does not rattle when you drive. Unblock the wheels.

JUMP STARTING YOUR VEHICLE

 The gases around the battery can explode if exposed to flames, sparks, or lit cigarettes. An explosion could result in injury or vehicle damage.

 Batteries contain sulfuric acid which can burn skin, eyes and clothing, if contacted.

Roadside Emergencies

Do not attempt to push-start your vehicle. Automatic transmissions do not have push-start capability; doing so may damage the catalytic converter.

Preparing your vehicle

When the battery is disconnected or a new battery is installed, the transmission must relearn its shift strategy. As a result, the transmission may have firm and/or soft shifts. This operation is considered normal and will not affect function or durability of the transmission. Over time, the adaptive learning process will fully update transmission operation.

1. **Use only a 12-volt supply to start your vehicle.**
2. Do not disconnect the battery of the disabled vehicle as this could damage the vehicle's electrical system.
3. Park the booster vehicle close to the hood of the disabled vehicle making sure the two vehicles **do not** touch. Set the parking brake on both vehicles and stay clear of the engine cooling fan and other moving parts.
4. Check all battery terminals and remove any excessive corrosion before you attach the battery cables. Ensure that vent caps are tight and level.
5. Turn the heater fan on in both vehicles to protect any electrical surges. Turn all other accessories off.

Connecting the jumper cables

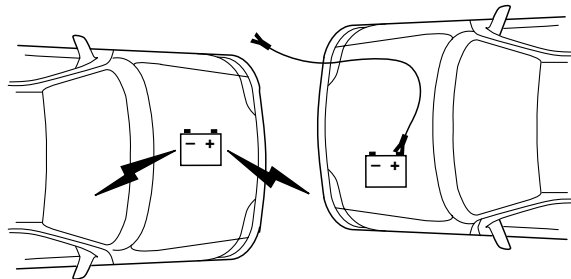

1. Connect the positive (+) jumper cable to the positive (+) terminal of the discharged battery.

Note: In the illustrations, *lightning bolts* are used to designate the assisting (boosting) battery.

Roadside Emergencies

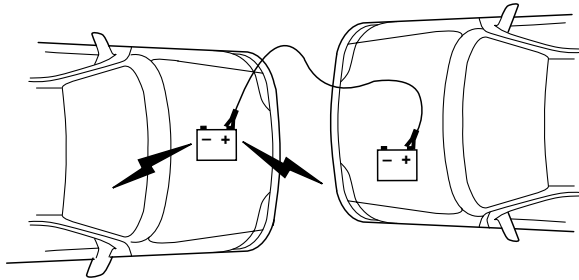

2. Connect the other end of the positive (+) cable to the positive (+) terminal of the assisting battery.

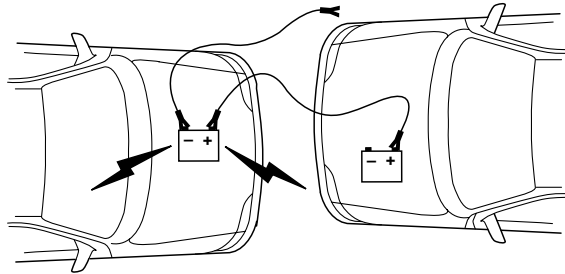

3. Connect the negative (-) cable to the negative (-) terminal of the assisting battery.

Roadside Emergencies

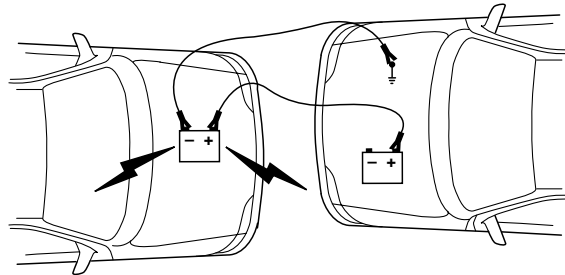

4. Make the final connection of the negative (-) cable to an exposed metal part of the stalled vehicle's engine, away from the battery and the carburetor/fuel injection system. **Do not** use fuel lines, engine rocker covers or the intake manifold as *grounding* points.



Do not connect the end of the second cable to the negative (-) terminal of the battery to be jumped. A spark may cause an explosion of the gases that surround the battery.

- 2.0L SPI engine

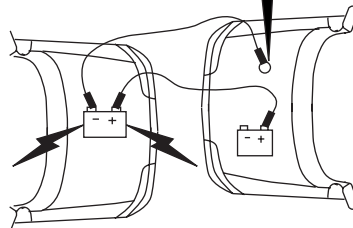
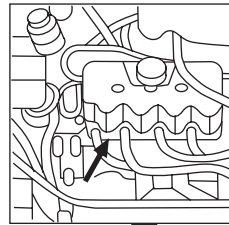

Roadside Emergencies

- 2.0L Zetec engine

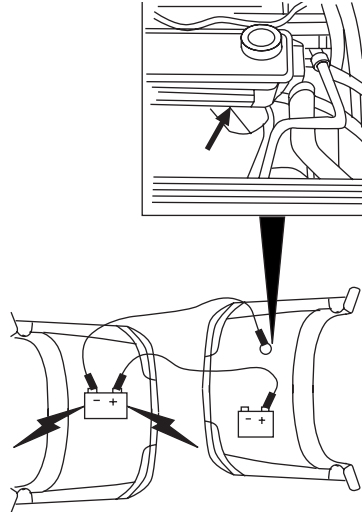

- 2.3L PZEV engine

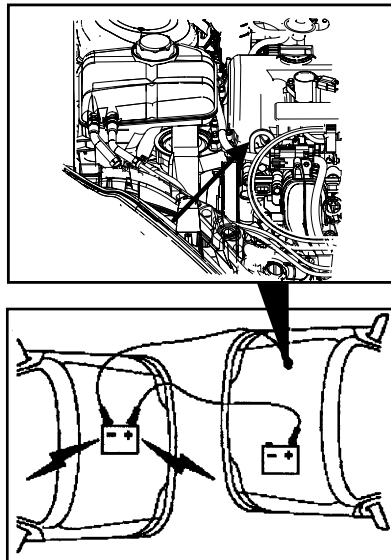

5. Ensure that the cables are clear of fan blades, belts, moving parts of both engines, or any fuel delivery system parts.

Roadside Emergencies

Jump starting

1. Start the engine of the booster vehicle and run the engine at moderately increased speed.
2. Start the engine of the disabled vehicle.
3. Once the disabled vehicle has been started, run both engines for an additional three minutes before disconnecting the jumper cables.

Removing the jumper cables

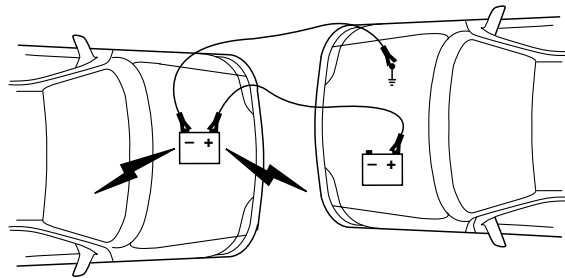

Remove the jumper cables in the reverse order that they were connected.

1. Remove the jumper cable from the *ground* metal surface.

Note: In the illustrations, *lightning bolts* are used to designate the assisting (boosting) battery.

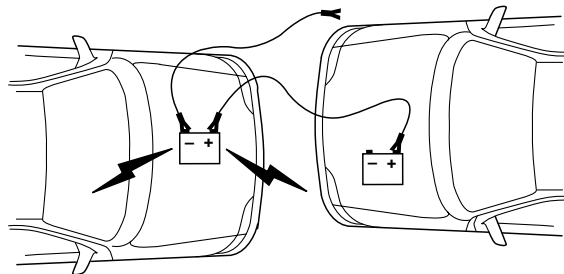

2. Remove the jumper cable on the negative (-) connection of the booster vehicle's battery.

Roadside Emergencies

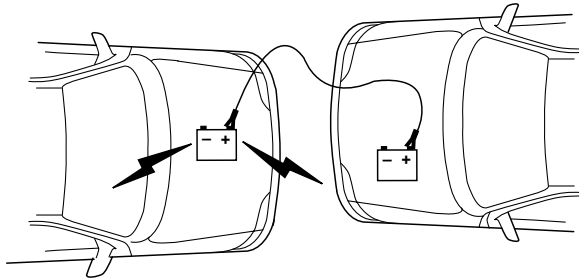

3. Remove the jumper cable from the positive (+) terminal of the booster vehicle's battery.

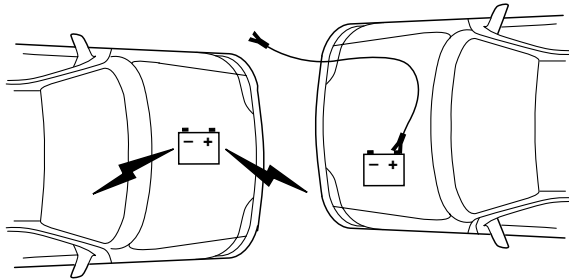

4. Remove the jumper cable from the positive (+) terminal of the disabled vehicle's battery.

After the disabled vehicle has been started and the jumper cables removed, allow it to idle for several minutes so the engine computer can *relearn* its idle conditions.

Roadside Emergencies

WRECKER TOWING

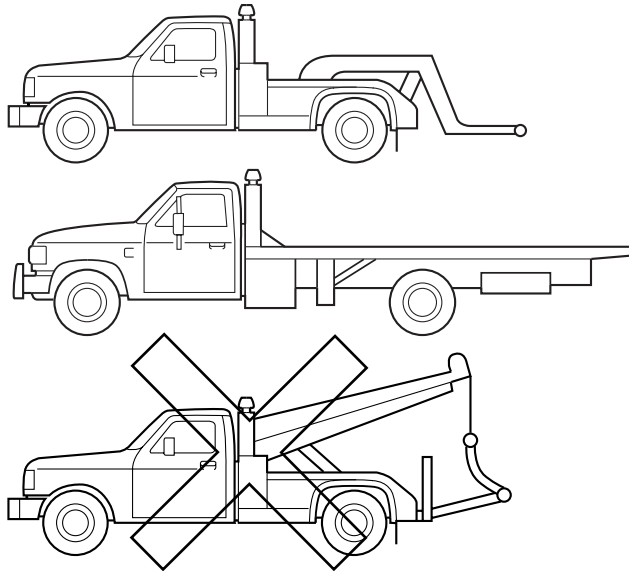

If you need to have your vehicle towed, contact a professional towing service or, if you are a member of a roadside assistance program, your roadside assistance service provider.

It is recommended that your vehicle be towed with a wheel lift or flatbed equipment. Do not tow with a slingbelt. Ford Motor Company has not approved a slingbelt towing procedure.

If your vehicle is to be towed from the rear using wheel lift equipment, the front wheels (drive wheels) must be placed on a dolly to prevent damage to the transmission.

If the vehicle is towed by other means or incorrectly, vehicle damage may occur.

Ford Motor Company produces a towing manual for all authorized tow truck operators. Have your tow truck operator refer to this manual for proper hook-up and towing procedures for your vehicle.

Customer Assistance

GETTING THE SERVICES YOU NEED

At home

You must take your Ford vehicle to an authorized Ford dealer for warranty repairs. While any Ford dealership handling your vehicle line will provide warranty service, we recommend you return to your selling dealer who wants to ensure your continued satisfaction. Please note that certain warranty repairs require special training and/or equipment, so not all dealers are authorized to perform all warranty repairs. This means that, depending on the warranty repair needed, you may have to take your vehicle to another dealer. A reasonable time must be allowed to perform a repair after taking your vehicle to the dealership. Repairs will be made using Ford or Motorcraft parts, or remanufactured or other parts that are authorized by Ford.

If you have questions or concerns, or are unsatisfied with the service you are receiving, follow these steps:

1. Contact your Sales Representative or Service Advisor at your selling/servicing dealership.
2. If your inquiry or concern remains unresolved, contact the Sales Manager, Service Manager or Customer Relations Manager.
3. If you require assistance or clarification on Ford Motor Company policies or procedures, please contact the Ford Customer Relationship Center at the number below.

Away from home

If you own a Ford or Mercury vehicle and are away from home when your vehicle needs service, or if you need more help than the dealership could provide, after following the steps described above, contact the Ford Customer Relationship Center to find an authorized dealership to help you.

In the United States:

Ford Motor Company
Customer Relationship Center
P.O. Box 6248
Dearborn, MI 48121
1-800-392-3673 (FORD)
(TDD for the hearing impaired: 1-800-232-5952)
www.customersaskford.com

Customer Assistance

In Canada:
Customer Relationship Centre
Ford Motor Company of Canada, Limited
P.O. Box 2000
Oakville, Ontario L6J 5E4
1-800-565-3673 (FORD)
www.ford.ca

If you own a Lincoln vehicle and are away from home when your vehicle needs service, or if you need more help than the dealership could provide, after following the steps described above, contact the Ford Customer Relationship Center to find an authorized dealership to help you.

In the United States:
Ford Motor Company
Customer Relationship Center
P.O. Box 6248
Dearborn, MI 48121
1-800-521-4140
(TDD for the hearing impaired: 1-800-232-5952)
www.customersaskford.com

In Canada:
Lincoln Centre
Ford Motor Company of Canada, Limited
P.O. Box 2000
Oakville, Ontario L6J 5E4
1-800-387-9333
www.lincolncanada.com

In order to help you service your Lincoln vehicle, please have the following information available when contacting the Lincoln Centre:

- Your telephone number (home and business)
- The name of the dealer and the city where the dealership is located
- The year and make of your vehicle
- The date of vehicle purchase
- The current odometer reading
- The vehicle identification number (VIN)

If you still have a complaint involving a warranty dispute, you may wish to contact the Dispute Settlement Board (U.S.).

Customer Assistance

In some states (in the U.S.) you must directly notify Ford in writing before pursuing remedies under your state's warranty laws. Ford is also allowed a final repair attempt in some states.

In the United States, a warranty dispute must be submitted to the Dispute Settlement Board before taking action under the Magnuson-Moss Warranty Act, or to the extent allowed by state law, before pursuing replacement or repurchase remedies provided by certain state laws. This dispute handling procedure is not required prior to enforcing state created rights or other rights which are independent of the Magnuson-Moss Warranty Act or state replacement or repurchase laws.

FORD EXTENDED SERVICE PLAN

You can get more protection for your new car or light truck by purchasing Ford Extended Service Plan (Ford ESP) coverage. It provides the following:

- Benefits during the warranty period depending on the plan you purchase (such as: reimbursement for rentals; coverage for certain maintenance and wear items).
- Protection against covered repair costs after your Bumper-to-Bumper Warranty expires.

You may purchase Ford ESP from any participating Ford and Lincoln Mercury and Ford of Canada dealer. There are several plans available in various time, distance and deductible combinations which can be tailored to fit your own driving needs. Ford ESP also offers reimbursement benefits for towing and rental coverage.

When you buy Ford ESP, you receive Peace-of-Mind protection throughout the United States and Canada, provided by a network of more than 5,000 participating Ford or Lincoln Mercury and Ford of Canada dealers.

If you did not take advantage of the Ford Extended Service Plan at the time of purchasing your vehicle, you may still be eligible. Since this information is subject to change, please ask your dealer for complete details about Ford Extended Service Plan coverage options, or visit the Ford ESP website at www.ford-esp.com.

Customer Assistance

THE DISPUTE SETTLEMENT BOARD (U.S. ONLY)

The Dispute Settlement Board is:

- an independent, third-party arbitration program for warranty disputes.
- available free to owners and lessees of qualifying Ford Motor Company vehicles.

The Dispute Settlement Board may not be available in all states. Ford Motor Company reserves the right to change eligibility limitations, modify procedures and/or to discontinue this service without notice and without incurring obligations per applicable state law.

What kinds of cases does the Board review?

Unresolved warranty repair concerns or vehicle performance concerns as on Ford and Lincoln Mercury cars and Ford and Lincoln Mercury light trucks which are within the terms of any applicable written new vehicle warranty are eligible for review, except those involving:

- a non-Ford product
- a non-Ford dealership
- sales disputes between customer and dealer except those associated with warranty repairs or concerns with the vehicle's performance as designed
- a request for reimbursement of consequential expenses unless a service or product concern is being reviewed
- items not covered by the New Vehicle Limited Warranty (including maintenance and wear items)
- alleged personal injury/property damage claims
- cases currently in litigation
- vehicles not used primarily for family, personal or household purposes (except in states where the Dispute Settlement Board is required to review commercial vehicles)
- vehicles with non-U.S. warranties

Concerns are ineligible for review if the New Vehicle Limited Warranty has expired at receipt of your application and, in certain states eligibility is dependent upon the customer's possession of the vehicle.

Eligibility may differ according to state law. For example, see the unique brochures for California, West Virginia, Georgia and Wisconsin purchasers/lessees.

152

2004 Focus (foc)
Owners Guide (post-2002-fmt)
USA English (fus)

Customer Assistance

Board membership

The Board consists of:

- Three consumer representatives
- A Ford or Lincoln Mercury dealership representative

Consumer candidates for Board membership are recruited and trained by an independent consulting firm. The dealership Board member is chosen from Ford and Lincoln Mercury dealership management, recognized for their business leadership qualities.

What the Board needs

To have your case reviewed you must complete the application in the DSB brochure and mail it to the address provided on the application form. Some states will require you to use certified mail, with return receipt requested.

Your application is reviewed and, if it is determined to be eligible, you will receive an acknowledgment indicating:

- The file number assigned to your application.
- The toll-free phone number of the DSB's independent administrator.

Your dealership and a Ford Motor Company representative will then be asked to submit statements.

To properly review your case, the Board needs the following information:

- Legible copies of all documents and maintenance or repair orders relevant to the case.
- The year, make, model, and Vehicle Identification Number (VIN) listed on your vehicle ownership license.
- The date of repair(s) and mileage at the time of occurrence(s).
- The current mileage.
- The name of the dealer(s) who sold or serviced the vehicle.
- A brief description of your unresolved concern.
- A brief summary of the action taken by the dealer(s) and Ford Motor Company.
- The names (if known) of all the people you contacted at the dealership(s).
- A description of the action you expect to resolve your concern.

You will receive a letter of explanation if your application does not qualify for Board review.

Customer Assistance

Oral presentations

If you would like to make an oral presentation, indicate YES to question 6 on the application. While it is your right to make an oral presentation before the Board, this is not a requirement and the Board will decide the case whether or not an oral presentation is made. An oral presentation may be requested by the Board as well.

Making a decision

Board members review all available information related to each complaint, including oral presentations, and arrive at a fair and impartial decision. Board review may be terminated at any time by either party.

Every effort is made to decide the case within 40 days of the date that all requested information is received by the Board. Since the Board generally meets once a month, it may take longer for the Board to consider some cases.

After a case is reviewed, the Board mails you a decision letter and a form on which to accept or reject the Board's decision. The decisions of the Board are binding on Ford (and, in some cases, on the dealer) but not on consumers who are free to pursue other remedies available to them under state or federal law.

To request a DSB Brochure/Application

For a brochure/application, speak to your dealer or write/call the Board at the following address/phone number:

Dispute Settlement Board
P.O. Box 1424
Waukesha, WI 53187-1424
1-800-428-3718

You may also contact the North American Customer Relationship Center at 1-800-392-3673 (Ford), TDD for the hearing impaired: 1-800-232-5952 or by writing to the Center at the following address:

Ford Motor Company
Customer Relationship Center
P.O. Box 6248
Dearborn, Michigan 48121

Customer Assistance

UTILIZING THE MEDIATION/ARBITRATION PROGRAM (CANADA ONLY)

In those cases where you continue to feel that the efforts by Ford and the dealer to resolve a factory-related vehicle service concern have been unsatisfactory, Ford of Canada participates in an impartial third party mediation/arbitration program administered by the Canadian Motor Vehicle Arbitration Plan (CAMVAP).

The CAMVAP program is a straight-forward and relatively speedy alternative to resolve a disagreement when all other efforts to produce a settlement have failed. This procedure is without cost to you and is designed to eliminate the need for lengthy and expensive legal proceedings.

In the CAMVAP program, impartial third-party arbitrators conduct hearings at mutually convenient times and places in an informal environment. These impartial arbitrators review the positions of the parties, make decisions and, when appropriate, render awards to resolve disputes. CAMVAP decisions are fast, fair, and final; the arbitrator's award is binding both to you and Ford of Canada.

CAMVAP services are available in all territories and provinces. For more information, without charge or obligation, call your CAMVAP Provincial Administrator directly at 1-800-207-0685.

GETTING ASSISTANCE OUTSIDE THE U.S. AND CANADA

Before exporting your vehicle to a foreign country, contact the appropriate foreign embassy or consulate. These officials can inform you of local vehicle registration regulations and where to find unleaded fuel.

If you cannot find unleaded fuel or can only get fuel with an anti-knock index lower than is recommended for your vehicle, contact a district or owner relations/customer relationship office.

The use of leaded fuel in your vehicle without proper conversion may damage the effectiveness of your emission control system and may cause engine knocking or serious engine damage. Ford Motor Company/Ford of Canada is not responsible for any damage caused by use of improper fuel.

In the United States, using leaded fuel may also result in difficulty importing your vehicle back into the U.S.

Customer Assistance

If your vehicle must be serviced while you are traveling or living in Central or South America, the Caribbean, or the Middle East, contact the nearest Ford dealership. If the dealership cannot help you, write or call:

FORD MOTOR COMPANY
WORLDWIDE DIRECT MARKET OPERATIONS
1555 Fairlane Drive
Fairlane Business Park #3
Allen Park, Michigan 48101
U.S.A.
Telephone: (313) 594-4857
FAX: (313) 390-0804

If you are in another foreign country, contact the nearest Ford dealership. If the dealership employees cannot help you, they can direct you to the nearest Ford affiliate office.

If you buy your vehicle in North America and then relocate outside of the U.S. or Canada, register your vehicle identification number (VIN) and new address with Ford Motor Company Worldwide Direct Market Operations.

ORDERING ADDITIONAL OWNER'S LITERATURE

To order the publications in this portfolio, contact Helm, Incorporated at:

HELM, INCORPORATED
P.O. Box 07150
Detroit, Michigan 48207

Or call:

For a free publication catalog, order toll free: 1-800-782-4356

Monday-Friday 8:00 a.m. - 6:00 p.m. EST

Helm, Incorporated can also be reached by their website:
www.helminc.com.

(Items in this catalog may be purchased by credit card, check or money order.)

Obtaining a French owner's guide

French Owner's Guides can be obtained from your dealer or by writing to Ford Motor Company of Canada, Limited, Service Publications, P.O. Box 1580, Station B, Mississauga, Ontario L4Y 4G3.

156

2004 Focus (foc)
Owners Guide (post-2002-fmt)
USA English (fus)

Customer Assistance

IN CALIFORNIA (U.S. ONLY)

California Civil Code Section 1793.2(d) requires that, if a manufacturer or its representative is unable to repair a motor vehicle to conform to the vehicle's applicable express warranty after a reasonable number of attempts, the manufacturer shall be required to either replace the vehicle with one substantially identical or repurchase the vehicle and reimburse the buyer in an amount equal to the actual price paid or payable by the consumer (less a reasonable allowance for consumer use). The consumer has the right to choose whether to receive a refund or replacement vehicle.

California Civil Code Section 1793.22(b) presumes that the manufacturer has had a reasonable number of attempts to conform the vehicle to its applicable express warranties if, within the first 18 months of ownership of a new vehicle or the first 29,000 km (18,000 miles), whichever occurs first:

1. Two or more repair attempts are made on the same non-conformity likely to cause death or serious bodily injury OR
2. Four or more repair attempts are made on the same nonconformity (a defect or condition that substantially impairs the use, value or safety of the vehicle) OR
3. The vehicle is out of service for repair of nonconformities for a total of more than 30 calendar days (not necessarily all at one time)

In the case of 1 or 2 above, the consumer must also notify the manufacturer of the need for the repair of the nonconformity at the following address:

Ford Motor Company
16800 Executive Plaza Drive
Mail Drop 3NE-B
Dearborn, MI 48126

Customer Assistance

REPORTING SAFETY DEFECTS (U.S. ONLY)

If you believe that your vehicle has a defect which could cause a crash or could cause injury or death, you should immediately inform the National Highway Traffic Safety



Administration (NHTSA) in addition to notifying Ford Motor Company.

If NHTSA receives similar complaints, it may open an investigation, and if it finds that a safety defect exists in a group of vehicles, it may order a recall and remedy campaign. However, NHTSA cannot become involved in individual problems between you, your dealer, or Ford Motor Company.

To contact NHTSA, you may either call the Auto Safety Hotline toll-free at 1-800-424-9393 (or 366-0123 in the Washington D.C. area) or write to:

NHTSA
400 Seventh Street
U.S. Department of Transportation
Washington, D.C. 20590

You can also obtain other information about motor vehicle safety from the Hotline.

WASHING THE EXTERIOR

Wash your vehicle regularly with cool or lukewarm water and a neutral Ph shampoo, such as Motorcraft Detail Wash (ZC-3-A), which is available from your dealer.

- Never use strong household detergents or soap, such as dish washing or laundry liquid. These products can discolor and spot painted surfaces.
- Never wash a vehicle that is “hot to the touch” or during exposure to strong, direct sunlight.
- Always use a clean sponge or car wash mitt with plenty of water for best results.
- Dry the vehicle with a chamois or soft terry cloth towel in order to eliminate water spotting.
- It is especially important to wash the vehicle regularly during the winter months, as dirt and road salt are difficult to remove and cause damage to the vehicle.
- Immediately remove items such as gasoline, diesel fuel, bird droppings and insect deposits because they can cause damage to the vehicle’s paintwork and trim over time.
- Remove any exterior accessories, such as antennas, before entering a car wash.
- **Suntan lotions and insect repellents can damage any painted surface; if these substances come in contact with your vehicle, wash off as soon as possible.**

WAXING

Applying a polymer paint sealant to your vehicle every six months will assist in reducing minor scratches and paint damage.

- Wash the vehicle first.
- Do not use waxes that contain abrasives.
- Do not allow paint sealant to come in contact with any non-body (low-gloss black) colored trim, such as grained door handles, roof racks, bumpers, side moldings, mirror housings or the windshield cowl area. The paint sealant will “gray” or stain the parts over time.

Cleaning

PAINT CHIPS

Your dealer has touch-up paint and sprays to match your vehicle's color. Take your color code (printed on a sticker in the driver's door jam) to your dealer to ensure you get the correct color.

- Remove particles such as bird droppings, tree sap, insect deposits, tar spots, road salt and industrial fallout before repairing paint chips.
- Always read the instructions before using the products.

ALUMINUM WHEELS AND WHEEL COVERS

Aluminum wheels and wheel covers are coated with a clearcoat paint finish. In order to maintain their shine:

- Clean weekly with Motorcraft Wheel and Tire Cleaner (ZC-37-A), which is available from your dealer. Heavy dirt and brake dust accumulation may require agitation with a sponge. Rinse thoroughly with a strong stream of water.
- Never apply any cleaning chemical to hot or warm wheel rims or covers.
- Some automatic car washes may cause damage to the finish on your wheel rims or covers. Chemical-strength cleaners, or cleaning chemicals, in combination with brush agitation to remove brake dust and dirt, could wear away the clearcoat finish over time.
- Do not use hydrofluoric acid-based or high caustic-based wheel cleaners, steel wool, fuels or strong household detergent.
- To remove tar and grease, use Motorcraft Bug and Tar Remover (ZC-42), available from your dealer.

ENGINE

Engines are more efficient when they are clean because grease and dirt buildup keep the engine warmer than normal.



The engine cooling fan may operate for several minutes after the engine is turned off. Do not start maintenance work until the fan has stopped operating.

When washing:

- Take care when using a power washer to clean the engine. The high-pressure fluid could penetrate the sealed parts and cause damage.
- Do not spray a hot engine with cold water to avoid cracking the engine block or other engine components.

160

2004 Focus (foc)
Owners Guide (post-2002-fmt)
USA English (fus)

Cleaning

- Spray Motorcraft Engine Shampoo and Degreaser (ZC-20) on all parts that require cleaning and pressure rinse clean.
- Never wash or rinse the engine while it is running; water in the running engine may cause internal damage.
- Cover the highlighted areas to prevent water damage when cleaning the engine.

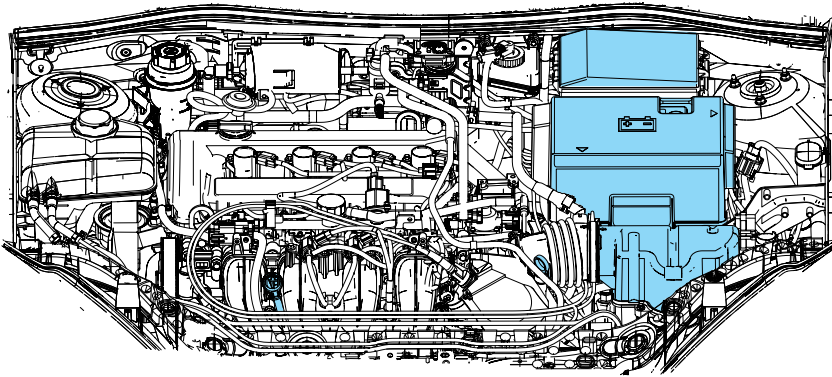

- **2.0L and 2.3L I4 Engines**

PLASTIC (NON-PAINTED) EXTERIOR PARTS

Use only approved products to clean plastic parts. These products are available from your dealer.

- For routine cleaning, use Motorcraft Detail Wash (ZC-3-A).
- If tar or grease spots are present, use Motorcraft Bug and Tar Remover (ZC-42).

WINDOWS AND WIPER BLADES

The windshield, rear and side windows and the wiper blades should be cleaned regularly. If the wipers do not wipe properly, substances on the vehicle's glass or the wiper blades may be the cause. These may include hot wax treatments used by commercial car washes, tree sap, or other organic contamination. To clean these items, please follow these tips:

- The windshield, rear windows and side windows may be cleaned with a non-abrasive cleaner such as Motorcraft Ultra Clear Spray Glass Cleaner (ZC-23), available from your dealer.
- Do not use abrasives, as they may cause scratches.

Cleaning

- Do not use fuel, kerosene, or paint thinner to clean any parts.
- Wiper blades can be cleaned with isopropyl (rubbing) alcohol or windshield washer solution. Be sure to replace wiper blades when they appear worn or do not function properly.

Do not use sharp objects, such as a razor blade, to clean the inside of the rear window or to remove decals, as it may cause damage to the rear window defroster's heated grid lines.

INSTRUMENT PANEL AND CLUSTER LENS

Clean the instrument panel with a damp cloth, then dry with a dry cloth.

- Avoid cleaners or polish that increase the gloss of the upper portion of the instrument panel. The dull finish in this area helps protect the driver from undesirable windshield reflection.



Do not use chemical solvents or strong detergents when cleaning the steering wheel or instrument panel to avoid contamination of the air bag system.

- Be certain to wash or wipe your hands clean if you have been in contact with certain products such as insect repellent and suntan lotion in order to avoid possible damage to the interior painted surfaces.

INTERIOR

For fabric, carpets, cloth seats, safety belts and seats equipped with side air bags:

- Remove dust and loose dirt with a vacuum cleaner.
- Remove light stains and soil with Motorcraft Extra Strength Upholstery Cleaner (ZC-41).
- If grease or tar is present on the material, spot-clean the area first with Motorcraft Spot and Stain Remover (ZC-14).
- Never saturate the seat covers with cleaning solution.
- Do not use household cleaning products or glass cleaners, which can stain and discolor the fabric and affect the flame retardant abilities of the seat materials.



Do not use cleaning solvents, bleach or dye on the vehicle's safety belts, as these actions may weaken the belt webbing.

Cleaning



Do not use chemical solvents or strong detergents when cleaning the seat-mounted side air bag. Such products could contaminate the side air bag system and affect performance of the side air bag in a collision.

LEATHER SEATS (IF EQUIPPED)

Your leather seating surfaces have a clear, protective coating over the leather.

- To clean, use a soft cloth with Motorcraft Deluxe Leather and Vinyl Cleaner (ZC-11-A). Dry the area with a soft cloth.
- To help maintain its resiliency and color, use the Motorcraft Deluxe Leather Care Kit (ZC-11-D), available from your authorized dealer.
- Do not use household cleaning products, alcohol solutions, solvents or cleaners intended for rubber, vinyl and plastics, or oil/petroleum-based leather conditioners. These products may cause premature wearing of the clear, protective coating.

Note: In some instances, color or dye transfer can occur when wet clothing comes in contact with leather upholstery. If this occurs, the leather should be cleaned immediately to avoid permanent staining.

UNDERBODY

Flush the complete underside of your vehicle frequently. Keep body and door drain holes free from packed dirt.

FORD, LINCOLN AND MERCURY CAR CARE PRODUCTS

Your Ford, Lincoln or Mercury dealer has many quality products available to clean your vehicle and protect its finishes. These quality products have been specifically engineered to fulfill your automotive needs; they are custom designed to complement the style and appearance of your vehicle. Each product is made from high quality materials that meet or exceed rigid specifications. For best results, use the following products or products of equivalent quality:

Motorcraft Custom Clearcoat Polish (ZC-8-A)

Motorcraft Custom Vinyl Protectant (not available in Canada) (ZC-40-A)

Motorcraft Vinyl Cleaner (Canada only) (CXC-93)

Motorcraft Vinyl Conditioner (Canada only) (CXC-94)

Motorcraft Deluxe Leather and Vinyl Cleaner (not available in Canada) (ZC-11-A)

Cleaning

Motorcraft Bug and Tar Remover (ZC-42)
Motorcraft Extra Strength Upholstery Cleaner (not available in Canada) (ZC-41)
Motorcraft Custom Bright Metal Cleaner (ZC-15)
Motorcraft Wheel and Tire Cleaner (ZC-37-A)
Motorcraft Dash and Vinyl Cleaner (ZC-38-A)
Motorcraft Car Care Kit (ZC-26)
Ford Premium Car Wash Concentrate (F2SZ-19523-WC)
Motorcraft Carlite Glass Cleaner (Canada only) (CXC-100)
Motorcraft Spot and Stain Remover (ZC-14)
Motorcraft Detail Wash (ZC-3-A)
Motorcraft Tire Clean and Shine (ZC-28)
Motorcraft Triple Clean (ZC-13)
Motorcraft Ultra-Clear Spray Glass Cleaner (not available in Canada) (ZC-23)
Motorcraft Engine Shampoo and Degreaser (ZC-20)

Maintenance and Specifications

SERVICE RECOMMENDATIONS

To help you service your vehicle:

- We highlight do-it-yourself items in the engine compartment for easy location.
- We provide a scheduled maintenance guide which makes tracking routine service easy.

If your vehicle requires professional service, your dealership can provide the necessary parts and service. Check your *Warranty Guide/Owner Information Guide* to find out which parts and services are covered.

Use only recommended fuels, lubricants, fluids and service parts conforming to specifications. Motorcraft parts are designed and built to provide the best performance in your vehicle.

PRECAUTIONS WHEN SERVICING YOUR VEHICLE

- Do not work on a hot engine.
- Make sure that nothing gets caught in moving parts.
- Do not work on a vehicle with the engine running in an enclosed space, unless you are sure you have enough ventilation.
- Keep all open flames and other burning (cigarettes) material away from the battery and all fuel related parts.

Working with the engine off

- Automatic transmission:
 1. Set the parking brake and shift to P (Park).
 2. Turn off the engine and remove the key.
 3. Block the wheels.
- Manual transmission:
 1. Set the parking brake, depress the clutch and place the gearshift in 1 (First).
 2. Turn off the engine and remove the key.
 3. Block the wheels.

Maintenance and Specifications

Working with the engine on

- Automatic transmission:
 1. Set the parking brake and shift to P (Park).
 2. Block the wheels.
- Manual transmission:
 1. Set the parking brake, depress the clutch and place the gearshift in N (Neutral).
 2. Block the wheels.

Note: Do not start your engine with the air cleaner removed and do not remove it while the engine is running.

OPENING THE HOOD

1. Inside the vehicle, pull the hood release handle located under the instrument panel.

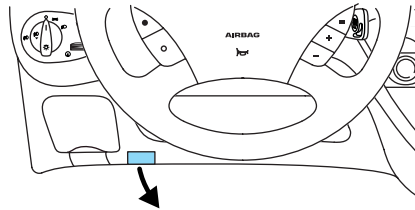

2. Go to the front of the vehicle and release the auxiliary latch that is located under the front of the hood.
3. Lift the hood and support it with the strut in the yellow-colored retainer; ensuring it is secure.



The engine cooling fan may operate for several minutes after the engine is turned off. Do not start maintenance work until the fan has stopped operating.

Maintenance and Specifications

IDENTIFYING COMPONENTS IN THE ENGINE COMPARTMENT

2.0L I4 SPI

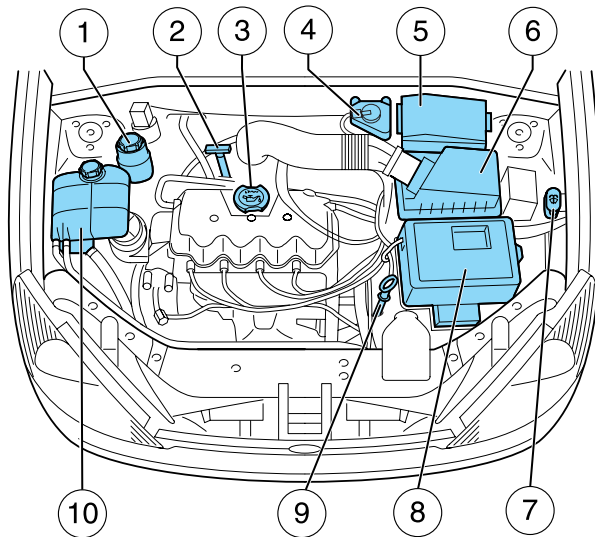

1. Power steering fluid reservoir
2. Engine oil dipstick
3. Engine oil filler cap
4. Brake/Clutch fluid reservoir
5. Power distribution box
6. Air filter assembly
7. Windshield washer fluid reservoir
8. Battery
9. Automatic transaxle fluid dipstick (if equipped)
10. Engine coolant reservoir

Maintenance and Specifications

2.0L Zetec-E Engine

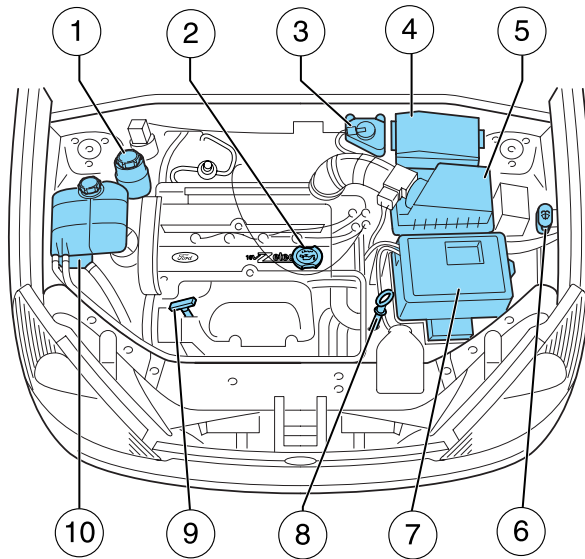

1. Power steering fluid reservoir
2. Engine oil filler cap
3. Brake/Clutch fluid reservoir
4. Power distribution box
5. Air filter assembly
6. Windshield washer fluid reservoir
7. Battery
8. Automatic transaxle fluid dipstick (if equipped)
9. Engine oil dipstick
10. Engine coolant reservoir

Maintenance and Specifications

2.3L I4 PZEV Engine

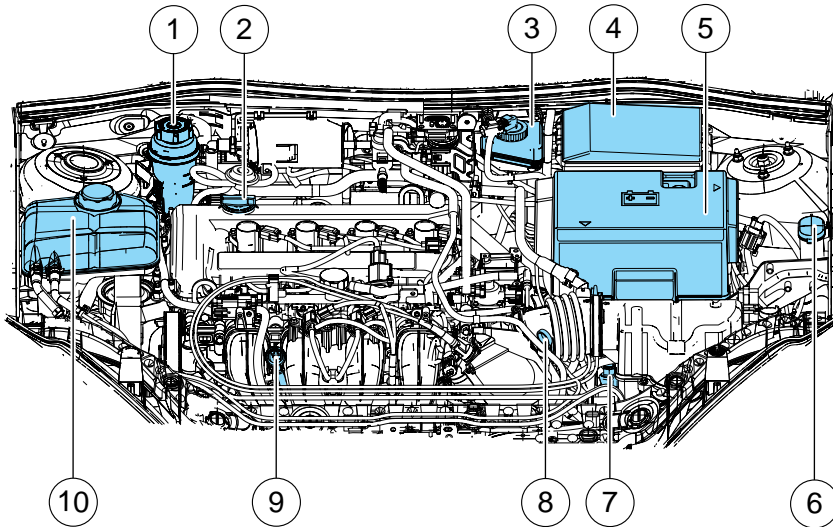

1. Power steering fluid reservoir
2. Engine oil filler cap
3. Brake/Clutch fluid reservoir
4. Power distribution box
5. Battery
6. Windshield washer fluid reservoir
7. Air filter service minder
8. Automatic transaxle fluid dipstick (if equipped)
9. Engine oil dipstick
10. Engine coolant reservoir

Maintenance and Specifications

WINDSHIELD WASHER FLUID

Add fluid to fill the reservoir if the level is low. In very cold weather, do not fill the reservoir completely.

Only use a washer fluid that meets Ford specification WSB-M8B16-A2. Refer to *Lubricant specifications* in this chapter.

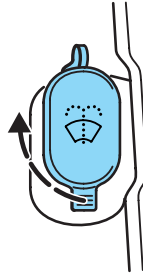

State or local regulations on volatile organic compounds may restrict the use of methanol, a common windshield washer antifreeze additive. Washer fluids containing non-methanol antifreeze agents should be used only if they provide cold weather protection without damaging the vehicle's paint finish, wiper blades or washer system.



If you operate your vehicle in temperatures below 4.5° C (40° F), use washer fluid with antifreeze protection. Failure to use washer fluid with antifreeze protection in cold weather could result in impaired windshield vision and increase the risk of injury or accident.

Note: Do not put washer fluid in the engine coolant reservoir. Washer fluid placed in the cooling system may harm engine and cooling system components.

ENGINE OIL

Checking the engine oil

Refer to the scheduled maintenance guide for the appropriate intervals for checking the engine oil.

1. Make sure the vehicle is on level ground.
2. Turn the engine off and wait a few minutes for the oil to drain into the oil pan.
3. Set the parking brake and ensure the gearshift is securely latched in P (automatic transaxle) or 1st (manual transaxle).
4. Open the hood. Protect yourself from engine heat.

Maintenance and Specifications

5. Locate and carefully remove the engine oil indicator (dipstick).

- 2.0L SPI/2.3L I4 engine

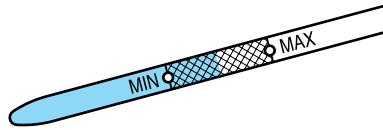

- 2.0L Zetec engine

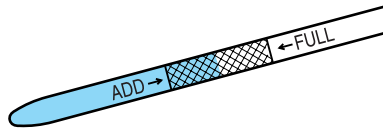

6. Wipe the indicator clean. Insert the indicator fully, then remove it again.

- If the oil level is **between the MIN and MAX marks** (2.0L SPI/2.3 engine) or **between ADD and FULL** (2.0L Zetec engine), the oil level is acceptable. **DO NOT ADD OIL.**
- 2.0L SPI

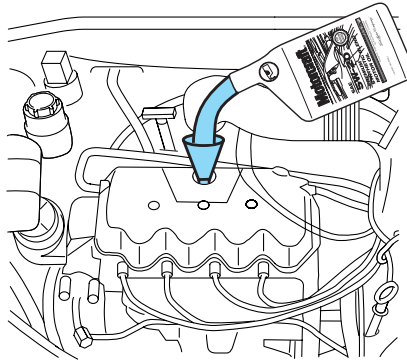

Maintenance and Specifications

- 2.0L Zetec

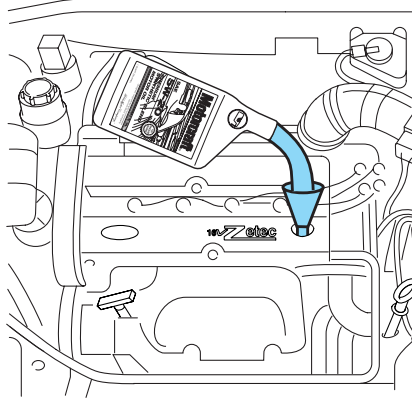

- 2.3L I4

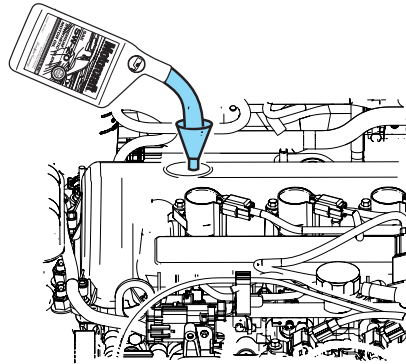

- If the oil level is below the MIN/ADD mark, add enough oil to raise the level within the MIN-MAX/ADD-FULL range.
 - Oil levels above the MAX/FULL mark may cause engine damage. Some oil must be removed from the engine by a service technician.
7. Put the indicator back in and ensure it is fully seated.

Adding engine oil

1. Check the engine oil. For instructions, refer to *Checking the engine oil* in this chapter.
2. If the engine oil level is not within the normal range, add only certified engine oil of the recommended viscosity. Remove the engine oil filler cap and use a funnel to pour the engine oil into the opening.

172

2004 Focus (foc)
Owners Guide (post-2002-fmt)
USA English (fus)

Maintenance and Specifications

3. Recheck the engine oil level. Make sure the oil level is not above the MAX mark on the engine oil level indicator (dipstick).
4. Install the indicator and ensure it is fully seated.
5. Fully install the engine oil filler cap by turning the filler cap clockwise tightly until clicks are heard, or until it is snug.

To avoid possible oil loss, DO NOT operate the vehicle with the engine oil level indicator and/or the engine oil filler cap removed.

Engine oil and filter recommendations

Look for this certification trademark.

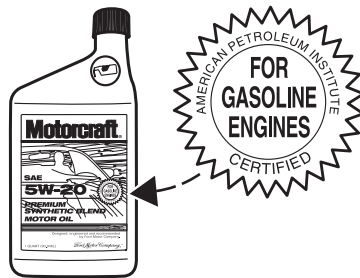

Use SAE 5W-20 engine oil.

Only use oils “Certified For Gasoline Engines” by the American Petroleum Institute (API). To protect your engine’s warranty use Motorcraft SAE 5W-20 or an equivalent 5W-20 oil meeting Ford specification WSS-M2C153-H. **SAE 5W-20 oil provides optimum fuel economy and durability performance meeting all requirements for your vehicle’s engine.**

Do not use supplemental engine oil additives, cleaners or other engine treatments. They are unnecessary and could lead to engine damage that is not covered by Ford warranty.

Change your engine oil and filter according to the appropriate schedule listed in the scheduled maintenance guide.

Ford production and aftermarket (Motorcraft) oil filters are designed for added engine protection and long life. If a replacement oil filter is used that does not meet Ford material and design specifications, start-up engine noises or knock may be experienced.

It is recommended you use the appropriate Motorcraft oil filter (or another brand meeting Ford specifications) for your engine application.

Maintenance and Specifications

BATTERY

Your vehicle is equipped with a Motorcraft maintenance-free battery which normally does not require additional water during its life of service.

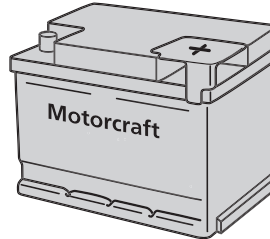

However, for severe usage or in high temperature climates, check the battery electrolyte level. Refer to the *Scheduled Maintenance Guide* for the service interval schedules.

Keep the electrolyte level in each cell up to the “level indicator”. Do not overfill the battery cells.

If the electrolyte level in the battery is low, you can add plain tap water to the battery, as long as you do not use hard water (water with a high mineral or alkali content). If possible, however, try to only fill the battery cells with distilled water. If the battery needs water often, have the charging system checked.

If your battery has a cover/shield, make sure it is reinstalled after the battery has been cleaned or replaced.

For longer, trouble-free operation, keep the top of the battery clean and dry. Also, make certain the battery cables are always tightly fastened to the battery terminals.

If you see any corrosion on the battery or terminals, remove the cables from the terminals and clean with a wire brush. You can neutralize the acid with a solution of baking soda and water.



Batteries normally produce explosive gases which can cause personal injury. Therefore, do not allow flames, sparks or lighted substances to come near the battery. When working near the battery, always shield your face and protect your eyes. Always provide proper ventilation.

Maintenance and Specifications



When lifting a plastic-cased battery, excessive pressure on the end walls could cause acid to flow through the vent caps, resulting in personal injury and/or damage to the vehicle or battery. Lift the battery with a battery carrier or with your hands on opposite corners.



Keep batteries out of reach of children. Batteries contain sulfuric acid. Avoid contact with skin, eyes or clothing. Shield your eyes when working near the battery to protect against possible splashing of acid solution. In case of acid contact with skin or eyes, flush immediately with water for a minimum of 15 minutes and get prompt medical attention. If acid is swallowed, call a physician immediately.



Battery posts, terminals and related accessories contain lead and lead compounds. **Wash hands after handling.**

Because your vehicle's engine is electronically controlled by a computer, some control conditions are maintained by power from the battery. When the battery is disconnected or a new battery is installed, the engine must relearn its idle and fuel trim strategy for optimum driveability and performance. To begin this process:

1. With the vehicle at a complete stop, set the parking brake.
 2. Put the gearshift in P (Park) (automatic transaxle) or the neutral position (manual transaxle), turn off all accessories and start the engine.
 3. Run the engine until it reaches normal operating temperature.
 4. Allow the engine to idle for at least one minute.
 5. Turn the A/C on and allow the engine to idle for at least one minute.
 6. Drive the vehicle to complete the relearning process.
- The vehicle may need to be driven 16 km (10 miles) or more to relearn the idle and fuel trim strategy.
 - **If you do not allow the engine to relearn its idle trim, the idle quality of your vehicle may be adversely affected until the idle trim is eventually relearned.**

When the battery is disconnected or a new battery installed, the transmission must learn its adaptive strategy. As a result of this, the transmission may shift firmly. This operation is considered normal and will fully update transmission operation to its optimum shift feel.

Maintenance and Specifications

If the battery has been disconnected or a new battery has been installed, the clock and the preset radio stations must be reset once the battery is reconnected.

- Always dispose of automotive batteries in a responsible manner. Follow your local authorized standards for disposal. Call your local authorized recycling center to find out more about recycling automotive batteries.

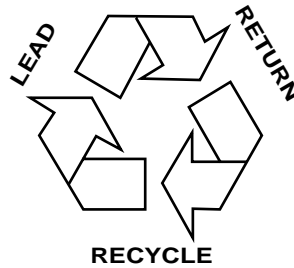

ENGINE COOLANT

Checking engine coolant

The concentration and level of engine coolant should be checked at the mileage intervals listed in the *Scheduled Maintenance Guide*. The coolant concentration should be maintained at 50/50 coolant and distilled water, which equates to a freeze point of -36°C (-34°F). Coolant concentration testing is possible with a hydrometer or antifreeze tester (such as the Rotunda Battery and Antifreeze Tester, 014-R1060). The level of coolant should be maintained at the "FULL COLD" or within the "COLD FILL RANGE" level in the coolant reservoir. If the level falls below, add coolant per the instructions in the *Adding engine coolant* section.

Your vehicle was factory-filled with a 50/50 engine coolant and water concentration. If the concentration of coolant falls below 40% or above 60%, the engine parts could become damaged or not work properly. **A 50-50 mixture of coolant and water provides the following:**

- **Freeze protection down to -36°C (-34°F).**
- **Boiling protection up to 129°C (265°F).**
- **Protection against rust and other forms of corrosion.**
- **Enables calibrated gauges to work properly.**

Maintenance and Specifications

When the engine is cold, check the level of the engine coolant in the reservoir.

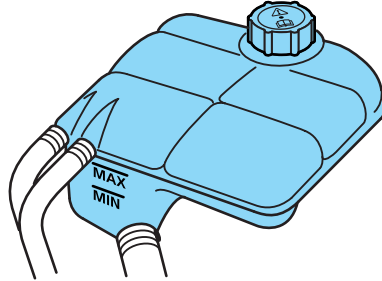

- The engine coolant should be at the “FULL COLD” level or within the “COLD FILL RANGE” as listed on the engine coolant reservoir (depending upon application).
- Refer to the *Scheduled Maintenance Guide* for service interval schedules.
- Be sure to read and understand *Precautions when servicing your vehicle* in this chapter.

If the engine coolant has not been checked at the recommended interval, the engine coolant reservoir may become low or empty. If the reservoir is low or empty, add engine coolant to the reservoir. Refer to *Adding engine coolant* in this chapter.

Note: Automotive fluids are not interchangeable; do not use engine coolant, antifreeze or windshield washer fluid outside of its specified function and vehicle location.

Adding engine coolant

When adding coolant, make sure it is a 50/50 mixture of engine coolant and distilled water. Add the mixture to the coolant reservoir, **when the engine is cool**, until the appropriate fill level is obtained.



Do not add engine coolant when the engine is hot. Steam and scalding liquids released from a hot cooling system can burn you badly. Also, you can be burned if you spill coolant on hot engine parts.



Do not put engine coolant in the windshield washer fluid container. If sprayed on the windshield, engine coolant could make it difficult to see through the windshield.

Maintenance and Specifications

- **Add Motorcraft Premium Gold Engine Coolant (yellow-colored), VC-7-A (U.S., except CA and OR), VC-7-B (CA and OR only), meeting Ford Specification WSS-M97B51-A1.**

Note: Use of Motorcraft Cooling System Stop Leak Pellets, VC-6, may darken the color of Motorcraft Premium Gold Engine Coolant from yellow to golden tan.

- **Do not add/mix an orange-colored, extended life coolant such as Motorcraft Speciality Orange Engine Coolant, VC-2 (US) or CXC-209 (Canada), meeting Ford specification WSS-M97B44-D with the factory-filled coolant.** Mixing Motorcraft Speciality Orange Engine Coolant or any orange-colored extended life product with your factory filled coolant can result in degraded corrosion protection.
- A large amount of water without engine coolant may be added, in case of emergency, to reach a vehicle service location. In this instance, the cooling system must be drained and refilled with a 50/50 mixture of engine coolant and distilled water as soon as possible. Water alone (without engine coolant) can cause engine damage from corrosion, overheating or freezing.
- **Do not use alcohol, methanol, brine or any engine coolants mixed with alcohol or methanol antifreeze (coolant).** Alcohol and other liquids can cause engine damage from overheating or freezing.
- **Do not add extra inhibitors or additives to the coolant.** These can be harmful and compromise the corrosion protection of the engine coolant.

For vehicles with overflow coolant systems with a non-pressurized cap on the coolant recovery system, add coolant to the coolant recovery reservoir when the engine is cool. Add the proper mixture of coolant and water to the "FULL COLD" level. For all other vehicles, which have a coolant degas system with a pressurized cap, or if it is necessary to remove the coolant pressure relief cap on the radiator of a vehicle with an overflow system, follow these steps to add engine coolant.



To reduce the risk of personal injury, make sure the engine is cool before unscrewing the coolant pressure relief cap. The cooling system is under pressure; steam and hot liquid can come out forcefully when the cap is loosened slightly.

1. Before you begin, turn the engine off and let it cool.

178

Maintenance and Specifications

2. When the engine is cool, wrap a thick cloth around the coolant pressure relief cap on the coolant reservoir (a translucent plastic bottle). Slowly turn cap counterclockwise (left) until pressure begins to release.
3. Step back while the pressure releases.
4. When you are sure that all the pressure has been released, use the cloth to turn it counterclockwise and remove the cap.
5. Fill the coolant reservoir slowly with the proper coolant mixture (see above), to within the “COLD FULL RANGE” or the “FULL COLD” level on the reservoir. If you removed the radiator cap in an overflow system, fill the radiator until the coolant is visible and radiator is almost full.
6. Replace the cap. Turn until tightly installed. (Cap must be tightly installed to prevent coolant loss.)

After any coolant has been added, check the coolant concentration, refer to *Checking engine coolant*. If the concentration is not 50/50 (protection to $-34^{\circ}\text{ F}/-36^{\circ}\text{ C}$), drain some coolant and adjust the concentration. It may take several drains and additions to obtain a 50/50 coolant concentration.

Whenever coolant has been added, the coolant level in the coolant reservoir should be checked the next few times you drive the vehicle. If necessary, add enough 50/50 concentration of engine coolant and distilled water to bring the liquid level to the proper level.

If you have to add more than 1.0 liter (1.0 quart) of engine coolant per month, have your dealer check the engine cooling system. Your cooling system may have a leak. Operating an engine with a low level of coolant can result in engine overheating and possible engine damage.

Recycled engine coolant

Ford Motor Company does NOT recommend the use of recycled engine coolant in vehicles originally equipped with Motorcraft Premium Gold Engine Coolant since a Ford-approved recycling process is not yet available.



Used engine coolant should be disposed of in an appropriate manner. Follow your community's regulations and standards for recycling and disposing of automotive fluids.

Maintenance and Specifications

Severe climates

If you drive in extremely cold climates (less than -36°C [-34°F):

- **It may be necessary to increase the coolant concentration above 50%.**
- **NEVER increase the coolant concentration above 60%.**
- **Increased engine coolant concentrations above 60% will decrease the overheat protection characteristics of the engine coolant and may cause engine damage.**
- **Refer to the chart on the coolant container to ensure the coolant concentration in your vehicle will provide adequate freeze protection at the temperatures in which you drive in the winter months.**

If you drive in extremely hot climates:

- **It is still necessary to maintain the coolant concentration above 40%.**
- **NEVER decrease the coolant concentration below 40%.**
- **Decreased engine coolant concentrations below 40% will decrease the corrosion protection characteristics of the engine coolant and may cause engine damage.**
- **Decreased engine coolant concentrations below 40% will decrease the freeze protection characteristics of the engine coolant and may cause engine damage.**
- **Refer to the chart on the coolant container to ensure the coolant concentration in your vehicle will provide adequate protection at the temperatures in which you drive.**

Vehicles driven year-round in non-extreme climates should use a 50/50 mixture of engine coolant and distilled water for optimum cooling system and engine protection.

Maintenance and Specifications

How fail-safe cooling works

If the engine begins to overheat:

- The engine coolant temperature gauge will move to the red (hot) area.
- The “Multi-function warning light: automatic transaxle/cooling system” will illuminate (2.0L Zetec engine only).
- The “Check Engine” indicator light will illuminate.

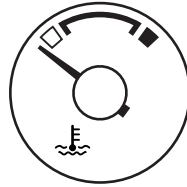

If the engine reaches a preset over-temperature condition, the engine will automatically switch to alternating cylinder operation. Each disabled cylinder acts as an air pump and cools the engine.

When this occurs the vehicle will still operate. However:

- The engine power will be limited.
- The air conditioning system will be disabled.

Continued operation will increase the engine temperature:

- The engine will completely shut down.
- Steering and braking effort will increase.

Once the engine temperature cools, the engine can be re-started. Take your vehicle to a service facility as soon as possible to minimize engine damage.

When fail-safe mode is activated

You have limited engine power when in the fail-safe mode, so drive the vehicle with caution. The vehicle will not be able to maintain high speed operation and the engine will run rough. Remember that the engine is capable of completely shutting down automatically to prevent engine damage, therefore:

1. Pull off the road as soon as safely possible and turn off the engine.
2. Arrange for the vehicle to be taken to a service facility.
3. If this is not possible, wait a short period for the engine to cool.
4. Check the coolant level and replenish if low.



Never remove the coolant reservoir cap while the engine is running or hot.

Maintenance and Specifications

5. Restart the engine and take your vehicle to a service facility.

Driving the vehicle without repairing the engine problem increases the chance of engine damage. Take your vehicle to a service facility as soon as possible.

WHAT YOU SHOULD KNOW ABOUT AUTOMOTIVE FUELS

Important safety precautions



Do not overfill the fuel tank. The pressure in an overfilled tank may cause leakage and lead to fuel spray and fire.



The fuel system may be under pressure. If the fuel filler cap is venting vapor or if you hear a hissing sound, wait until it stops before completely removing the fuel filler cap. Otherwise, fuel may spray out and injure you or others.



If you do not use the proper fuel filler cap, excessive pressure or vacuum in the fuel tank may damage the fuel system or cause the fuel cap to disengage in a collision, which may result in possible personal injury.



Automotive fuels can cause serious injury or death if misused or mishandled.



Gasoline may contain benzene, which is a cancer-causing agent.

Observe the following guidelines when handling automotive fuel:

- Extinguish all smoking materials and any open flames before fueling your vehicle.
- Always turn off the vehicle before fueling.
- Automotive fuels can be harmful or fatal if swallowed. Fuel such as gasoline is highly toxic and if swallowed can cause death or permanent injury. If fuel is swallowed, call a physician immediately, even if no symptoms are immediately apparent. The toxic effects of fuel may not be visible for hours.



Maintenance and Specifications

- Avoid inhaling fuel vapors. Inhaling too much fuel vapor of any kind can lead to eye and respiratory tract irritation. In severe cases, excessive or prolonged breathing of fuel vapor can cause serious illness and permanent injury.
- Avoid getting fuel liquid in your eyes. If fuel is splashed in the eyes, remove contact lenses (if worn), flush with water for 15 minutes and seek medical attention. Failure to seek proper medical attention could lead to permanent injury.
- Fuels can also be harmful if absorbed through the skin. If fuel is splashed on the skin and/or clothing, promptly remove contaminated clothing and wash skin thoroughly with soap and water. Repeated or prolonged skin contact with fuel liquid or vapor causes skin irritation.
- Be particularly careful if you are taking “Antabuse” or other forms of disulfiram for the treatment of alcoholism. Breathing gasoline vapors, or skin contact could cause an adverse reaction. In sensitive individuals, serious personal injury or sickness may result. If fuel is splashed on the skin, promptly wash skin thoroughly with soap and water. Consult a physician immediately if you experience an adverse reaction.



When refueling always shut the engine off and never allow sparks or open flames near the filler neck. Never smoke while refueling. Fuel vapor is extremely hazardous under certain conditions. Care should be taken to avoid inhaling excess fumes.



The flow of fuel through a fuel pump nozzle can produce static electricity, which can cause a fire if fuel is pumped into an ungrounded fuel container.

Use the following guidelines to avoid static build-up when filling an ungrounded fuel container:

- Place approved fuel container on the ground.
- DO NOT fill a fuel container while it is in the vehicle (including the cargo area).
- Keep the fuel pump nozzle in contact with the fuel container while filling.
- DO NOT use a device that would hold the fuel pump handle in the fill position.

Maintenance and Specifications

Fuel Filler Cap

Your fuel tank filler cap has an SAE full thread pattern.

When fueling your vehicle:

1. Turn the engine off.
2. Carefully turn the filler cap counterclockwise until it stops.
3. Pull to remove the cap from the fuel filler pipe.
4. To install the cap, align the tabs on the cap with the notches on the filler pipe.
5. Turn the filler cap clockwise until four clicks are heard.

If the “Service Engine Soon/Check Engine” indicator comes on and stays on after you start the engine, the fuel filler cap may not be properly installed. Turn off the engine, remove the fuel filler cap, align the cap properly and reinstall it.

If you must replace the fuel filler cap, replace it with a fuel filler cap that is designed for your vehicle. The customer warranty may be void for any damage to the fuel tank or fuel system if the correct genuine Ford or Motorcraft fuel filler cap is not used.



The fuel system may be under pressure. If the fuel filler cap is venting vapor or if you hear a hissing sound, wait until it stops before completely removing the fuel filler cap. Otherwise, fuel may spray out and injure you or others.



If you do not use the proper fuel filler cap, excessive pressure or vacuum in the fuel tank may damage the fuel system or cause the fuel cap to disengage in a collision, which may result in possible personal injury.

Choosing the right fuel

Use only UNLEADED FUEL. The use of leaded fuel is prohibited by law and could damage your vehicle.

Do not use fuel containing methanol. It can damage critical fuel system components.

Your vehicle was not designed to use fuel or fuel additives with metallic compounds, including manganese-based additives. Studies indicate that these additives can cause your vehicle’s emission control system to deteriorate more rapidly. In Canada, many fuels contain critical fuel system components.

184

2004 Focus (foc)
Owners Guide (post-2002-fmt)
USA English (fus)

Maintenance and Specifications

Do not use fuel containing methanol. It can damage critical fuel system components.

Repairs to correct the effects of using a fuel for which your vehicle was not designed may not be covered by your warranty.

Octane recommendations

Your vehicle is designed to use “Regular” unleaded gasoline with pump (R+M)/2 octane rating of 87. We do not recommend the use of gasolines labeled as “Regular” that are sold with octane ratings of 86 or lower in high altitude areas.

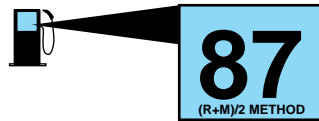

Do not be concerned if your engine sometimes knocks lightly. However, if it knocks heavily under most driving conditions while you are using fuel with the recommended octane rating, see your dealer or a qualified service technician to prevent any engine damage.

Fuel quality

If you are experiencing starting, rough idle or hesitation driveability problems, try a different brand of unleaded gasoline. “Premium” unleaded gasoline is not recommended for vehicles designed to use “Regular” unleaded gasoline because it may cause these problems to become more pronounced. If the problems persist, see your dealer or a qualified service technician.

It should not be necessary to add any aftermarket products to your fuel tank if you continue to use high quality fuel of the recommended octane rating. Aftermarket products could cause damage to the fuel system. Repairs to correct the effects of using an aftermarket product in your fuel may not be covered by your warranty.

Many of the world’s automakers approved the World-wide Fuel Charter that recommends gasoline specifications to provide improved performance and emission control system protection for your vehicle. Gasolines that meet the World-wide Fuel Charter should be used when available. Ask your fuel supplier about gasolines that meet the World-wide Fuel Charter.

Cleaner air

Ford endorses the use of reformulated “cleaner-burning” gasolines to improve air quality.

Maintenance and Specifications

Running out of fuel

Avoid running out of fuel because this situation may have an adverse affect on powertrain components.

If you have run out of fuel:

- You may need to cycle the ignition from OFF to ON several times after refueling, to allow the fuel system to pump the fuel from the tank to the engine.
- The  indicator may come on. For more information on the “Check Engine” indicator, refer to the *Instrument Cluster* chapter.

Fuel Filter

For fuel filter replacement, see your dealer or a qualified service technician. Refer to the scheduled maintenance guide for the appropriate intervals for changing the fuel filter.

Replace the fuel filter with an authorized Motorcraft part. The customer warranty may be void for any damage to the fuel system if an authorized Motorcraft fuel filter is not used.

ESSENTIALS OF GOOD FUEL ECONOMY

Measuring techniques

Your best source of information about actual fuel economy is you, the driver. You must gather information as accurately and consistently as possible. Fuel expense, frequency of fill-ups or fuel gauge readings are NOT accurate as a measure of fuel economy. We do not recommend taking fuel economy measurements during the first 1,600 km (1,000 miles) of driving (engine break-in period). You will get a more accurate measurement after 3,000 km–5,000 km (2,000 miles–3,000 miles).

Filling the tank

The advertised fuel capacity of the fuel tank on your vehicle is equal to the rated refill capacity of the fuel tank as listed in the *Refill capacities* section of this chapter.

The advertised capacity is the amount of the indicated capacity and the empty reserve combined. Indicated capacity is the difference in the amount of fuel in a full tank and a tank when the fuel gauge indicates empty. Empty reserve is the small amount of fuel remaining in the fuel tank after the fuel gauge indicates empty.

The amount of usable fuel in the empty reserve varies and should not be relied upon to increase driving range. When refueling your

Maintenance and Specifications

vehicle after the fuel gauge indicates empty, you might not be able to refuel the full amount of the advertised capacity of the fuel tank due to the empty reserve still present in the tank.

For consistent results when filling the fuel tank:

- Turn the engine/ignition switch to the off position prior to refueling, an error in the reading will result if the engine is left running.
- Use the same filling rate setting (low — medium — high) each time the tank is filled.
- Allow no more than 2 automatic click-offs when filling.
- Always use fuel with the recommended octane rating.
- Use a known quality gasoline, preferably a national brand.
- Use the same side of the same pump and have the vehicle facing the same direction each time you fill up.
- Have the vehicle loading and distribution the same every time.

Your results will be most accurate if your filling method is consistent.

Calculating fuel economy

1. Fill the fuel tank completely and record the initial odometer reading (in kilometers or miles).
2. Each time you fill the tank, record the amount of fuel added (in liters or gallons).
3. After at least three to five tank fill-ups, fill the fuel tank and record the current odometer reading.
4. Subtract your initial odometer reading from the current odometer reading.
5. Follow one of the simple calculations in order to determine fuel economy:

Calculation 1: **Multiply liters used by 100, then divide by total kilometers traveled.**

Calculation 2: **Divide total miles traveled by total gallons used.**

Keep a record for at least one month and record the type of driving (city or highway). This will provide an accurate estimate of the vehicle's fuel economy under current driving conditions. Additionally, keeping records during summer and winter will show how temperature impacts fuel economy. In general, lower temperatures give lower fuel economy.

Driving style — good driving and fuel economy habits

Give consideration to the lists that follow and you may be able to change a number of variables and improve your fuel economy.

Maintenance and Specifications

Habits

- Smooth, moderate operation can yield up to 10% savings in fuel.
- Steady speeds without stopping will usually give the best fuel economy.
- Idling for long periods of time (greater than one minute) may waste fuel.
- Anticipate stopping; slowing down may eliminate the need to stop.
- Sudden or hard accelerations may reduce fuel economy.
- Slow down gradually.
- Driving at reasonable speeds (traveling at 88 km/h [55 mph] uses 15% less fuel than traveling at 105 km/h [65 mph]).
- Revving the engine before turning it off may reduce fuel economy.
- Using the air conditioner or defroster may reduce fuel economy.
- You may want to turn off the speed control in hilly terrain if unnecessary shifting between third and fourth gear occurs. Unnecessary shifting of this type could result in reduced fuel economy.
- Warming up a vehicle on cold mornings is not required and may reduce fuel economy.
- Resting your foot on the brake pedal while driving may reduce fuel economy.
- Combine errands and minimize stop-and-go driving.

Maintenance

- Keep tires properly inflated and use only recommended size.
- Operating a vehicle with the wheels out of alignment will reduce fuel economy.
- Use recommended engine oil. Refer to *Lubricant specifications* in this chapter.
- Perform all regularly scheduled maintenance items. Follow the recommended maintenance schedule and owner maintenance checks found in your vehicle scheduled maintenance guide.

Conditions

- Heavily loading a vehicle or towing a trailer may reduce fuel economy at any speed.
- Carrying unnecessary weight may reduce fuel economy (approximately 0.4 km/L [1 mpg] is lost for every 180 kg [400 lb] of weight carried).

188

2004 Focus (foc)
Owners Guide (post-2002-fmt)
USA English (fus)

Maintenance and Specifications

- Adding certain accessories to your vehicle (for example bug deflectors, rollbars/light bars, running boards, ski/luggage racks) may reduce fuel economy.
- Using fuel blended with alcohol may lower fuel economy.
- Fuel economy may decrease with lower temperatures during the first 12–16 km (8–10 miles) of driving.
- Driving on flat terrain offers improved fuel economy as compared to driving on hilly terrain.
- Transaxles give their best fuel economy when operated in the top cruise gear and with steady pressure on the gas pedal.
- Close windows for high speed driving.

EPA window sticker

Every new vehicle should have the EPA window sticker. Contact your dealer if the window sticker is not supplied with your vehicle. The EPA window sticker should be your guide for the fuel economy comparisons with other vehicles.

It is important to note the box in the lower left corner of the window sticker. These numbers represent the Range of L/100 km (MPG) expected on the vehicle under optimum conditions. Your fuel economy may vary depending upon the method of operation and conditions.

EMISSION CONTROL SYSTEM

Your vehicle is equipped with various emission control components and a catalytic converter which will enable your vehicle to comply with applicable exhaust emission standards. To make sure that the catalytic converter and other emission control components continue to work properly:

- Use only the specified fuel listed.
- Avoid running out of fuel.
- Do not turn off the ignition while your vehicle is moving, especially at high speeds.
- Have the items listed in your *Scheduled Maintenance Guide* performed according to the specified schedule.

The scheduled maintenance items listed in the *Scheduled Maintenance Guide* are essential to the life and performance of your vehicle and to its emissions system.

If other than Ford, Motorcraft or Ford-authorized parts are used for maintenance replacements or for service of components affecting

Maintenance and Specifications

emission control, such non-Ford parts should be equivalent to genuine Ford Motor Company parts in performance and durability.



Do not park, idle, or drive your vehicle in dry grass or other dry ground cover. The emission system heats up the engine compartment and exhaust system, which can start a fire.

Illumination of the  indicator, charging system warning light or the temperature warning light, fluid leaks, strange odors, smoke or loss of engine power, could indicate that the emission control system is not working properly.



Exhaust leaks may result in entry of harmful and potentially lethal fumes into the passenger compartment.

Do not make any unauthorized changes to your vehicle or engine. By law, vehicle owners and anyone who manufactures, repairs, services, sells, leases, trades vehicles, or supervises a fleet of vehicles are not permitted to intentionally remove an emission control device or prevent it from working. Information about your vehicle's emission system is on the Vehicle Emission Control Information Decal located on or near the engine. This decal identifies engine displacement and gives some tune up specifications.

Please consult your *Warranty Guide* for complete emission warranty information.

On board diagnostics (OBD-II)

Your vehicle is equipped with a computer that monitors the engine's emission control system. This system is commonly known as the On Board Diagnostics System (OBD-II). This OBD-II system protects the environment by ensuring that your vehicle continues to meet government emission standards. The OBD-II system also assists the service technician in properly servicing your vehicle. When the *Check engine/Service engine soon* light illuminates, the OBD-II system has detected a malfunction. Temporary malfunctions may cause your *Check engine/Service engine soon* light to illuminate. Examples are:

1. The vehicle has run out of fuel. (The engine may misfire or run poorly.)
2. Poor fuel quality or water in the fuel.
3. The fuel cap may not have been securely tightened.

190



2004 Focus (foc)
Owners Guide (post-2002-fmt)
USA English (fus)

Maintenance and Specifications

These temporary malfunctions can be corrected by filling the fuel tank with good quality fuel and/or properly tightening the fuel cap. After three driving cycles without these or any other temporary malfunctions present, the *Check engine/Service engine soon* light should turn off. (A driving cycle consists of a cold engine startup followed by mixed city/highway driving.) No additional vehicle service is required.

If the *Check engine/Service engine soon* light remains on, have your vehicle serviced at the first available opportunity.

Readiness for Inspection/Maintenance (I/M) testing

In some localities, it may be a legal requirement to pass an I/M test of the on-board diagnostics system. If your  indicator is on, refer to the description in the *Warning lights and chimes* section of the *Instrument Cluster* chapter. Your vehicle may not pass the I/M test with the  indicator on.

If the vehicle's powertrain system or its battery has just been serviced, the on-board diagnostics system is reset to a "not ready for I/M test" condition. To ready the on-board diagnostics system for I/M testing, a minimum of 30 minutes of city and highway driving is necessary as described below:

- First, at least 10 minutes of driving on an expressway or highway.
- Next, at least 20 minutes driving in stop-and-go, city-type traffic with at least four idle periods.

Allow the vehicle to sit for at least eight hours without starting the engine. Then, start the engine and complete the above driving cycle. The engine must warm up to its normal operating temperature. Once started, do not turn off the engine until the above driving cycle is complete.

Maintenance and Specifications

CHECKING AND ADDING POWER STEERING FLUID

Check the fluid. Refer to the *Scheduled Maintenance Guide* for service maintenance schedules.

1. Start the engine and let it run until it reaches normal operating schedules.
2. Turn the steering wheel left and right several times.
3. Turn the engine off.
4. Check the fluid level.
5. If the fluid is below the MIN line, add fluid in small amounts until it reaches the correct level (between the MIN and MAX lines).

Use only MERCON® ATF.



BRAKE/CLUTCH FLUID RESERVOIR

Brake and clutch systems are supplied from the same reservoir.

The fluid level will drop slowly as the brakes wear, and will rise when the brake components are replaced. Fluid levels between the “MIN” and “MAX” lines are within the normal operating range, there is no need to add fluid. If the fluid levels are outside of the normal operating range, the performance of your brake system could be compromised, seek service from your dealer immediately.

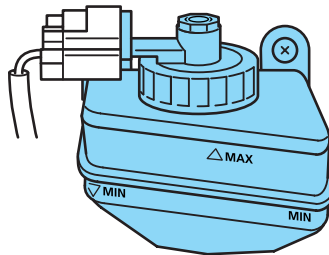

Maintenance and Specifications

CLUTCH FLUID (IF EQUIPPED)

The clutch master cylinder and brake master cylinder are part of the same system; both are refillable through the brake master cylinder with brake fluid. For more information on brake fluid maintenance, refer to *Brake fluid* in this chapter.

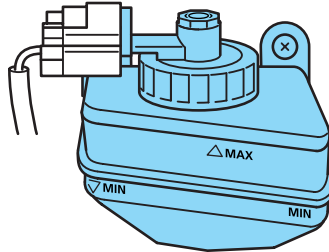

Brake fluid is toxic. If brake fluid contacts the eyes, flush eyes with running water for 15 minutes. Seek medical attention if irritation persists. If taken internally, drink water and induce vomiting. Seek medical attention immediately.

TRANSMISSION FLUID

Checking automatic transmission fluid

Refer to your *Scheduled Maintenance Guide* for scheduled intervals for fluid checks and changes. Your transaxle does not consume fluid. However, the fluid level should be checked if the transaxle is not working properly, i.e., if the transaxle slips or shifts slowly or if you notice some sign of fluid leakage.

Automatic transmission fluid expands when warmed. To obtain an accurate fluid check, drive the vehicle until it is warmed up (approximately 30 km [20 miles]). If your vehicle has been operated for an extended period at high speeds, in city traffic during hot weather or pulling a trailer, the vehicle should be turned off for about 30 minutes to allow fluid to cool before checking.

1. Drive the vehicle 30 km (20 miles) or until it reaches normal operating temperature.
2. Park the vehicle on a level surface and engage the parking brake.
3. With the parking brake engaged and your foot on the brake pedal, start the engine and move the gearshift lever through all of the gear ranges. Allow sufficient time for each gear to engage.
4. Latch the gearshift lever in P (Park) and leave the engine running.

Maintenance and Specifications

5. Remove the dipstick, wiping it clean with a clean, dry lint free rag. If necessary, refer to *Identifying components in the engine compartment* in this chapter for the location of the dipstick.
6. Install the dipstick making sure it is fully seated in the filler tube.
7. Remove the dipstick and inspect the fluid level. The fluid should be in the designated areas for normal operating temperature.

Low fluid level

Do not drive the vehicle if the fluid level is at the bottom of the dipstick and the outside temperatures are above 10°C (50°F).

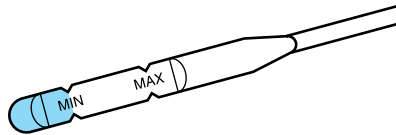

Correct fluid level

The transmission fluid should be checked at normal operating temperatures 66°C-77°C (150°F-170°F) on a level surface. The normal operating temperature can be reached after approximately 30 km (20 miles) of driving.

The transmission fluid should be in this range if at normal operating temperature (66°C-77°C [150°F-170°F]).

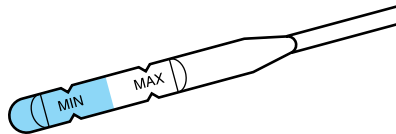

High fluid level

Fluid levels above the safe range may result in transaxle failure. An overfill condition of transmission fluid may cause shift and/or engagement concerns and/or possible damage.

High fluid levels can be caused by an overheating condition.

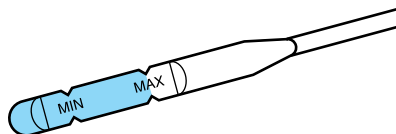

Maintenance and Specifications

Adjusting automatic transmission fluid levels

Before adding any fluid, make sure the correct type is used. The type of fluid used is normally indicated on the dipstick and also in the *Lubricant specifications* section in this chapter.

Use of a non-approved automatic transmission fluid may cause internal transaxle component damage.

If necessary, add fluid in 250 mL (1/2 pint) increments through the filler tube until the level is correct.

If an overfill occurs, excess fluid should be removed by a qualified technician.

An overfill condition of transmission fluid may cause shift and/or engagement concerns and/or possible damage.

Do not use supplemental transmission fluid additives, treatments or cleaning agents. The use of these materials may affect transmission operation and result in damage to internal transmission components.

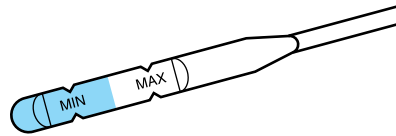

Checking and adding manual transmission fluid (if equipped)

1. Clean the filler plug.
2. Remove the filler plug and inspect the fluid level.
3. Fluid level should be at the bottom of the opening.
4. Add enough fluid through the filler opening so that the fluid level is at the bottom of the opening.
5. Install and tighten the fill plug securely.

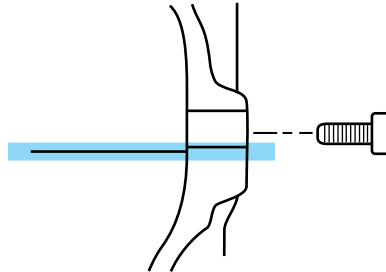

Use only fluid that meets Ford specifications. Refer to *Lubricant specifications* in this chapter.

Maintenance and Specifications

INFORMATION ABOUT UNIFORM TIRE QUALITY GRADING

New vehicles are fitted with tires that have a rating on them called Tire Quality Grades. The Quality grades can be found where applicable on the tire sidewall between tread shoulder and maximum section width. For example:

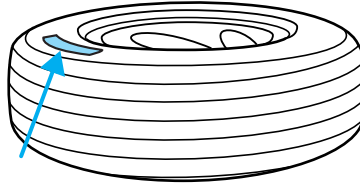

- **Treadwear 200 Traction AA Temperature A**

These Tire Quality Grades are determined by standards that the United States Department of Transportation has set.

Tire Quality Grades apply to new pneumatic tires for use on passenger cars. They do not apply to deep tread, winter-type snow tires, space-saver or temporary use spare tires, tires with nominal rim diameters of 10 to 12 inches or limited production tires as defined in Title 49 Code of Federal Regulations Part 575.104(c)(2).

U.S. Department of Transportation-Tire quality grades: The U.S. Department of Transportation requires Ford to give you the following information about tire grades exactly as the government has written it.

Treadwear

The treadwear grade is a comparative rating based on the wear rate of the tire when tested under controlled conditions on a specified government test course. For example, a tire graded 150 would wear one and one-half (1 1/2) times as well on the government course as a tire graded 100. The relative performance of tires depends upon the actual conditions of their use, however, and may depart significantly from the norm due to variations in driving habits, service practices, and differences in road characteristics and climate.

Traction AA A B C

The traction grades, from highest to lowest are AA, A, B, and C. The grades represent the tire's ability to stop on wet pavement as measured under controlled conditions on specified government test surfaces of asphalt and concrete. A tire marked C may have poor traction performance.



The traction grade assigned to this tire is based on straight-ahead braking traction tests, and does not include acceleration, cornering, hydroplaning or peak traction characteristics.

Maintenance and Specifications

Temperature A B C

The temperature grades are A (the highest), B and C, representing the tire's resistance to the generation of heat and its ability to dissipate heat when tested under controlled conditions on a specified indoor laboratory test wheel. Sustained high temperature can cause the material of the tire to degenerate and reduce tire life, and excessive temperature can lead to sudden tire failure. The grade C corresponds to a level of performance which all passenger car tires must meet under the Federal Motor Vehicle Safety Standard No. 109. Grades B and A represent higher levels of performance on the laboratory test wheel than the minimum required by law.



The temperature grade for this tire is established for a tire that is properly inflated and not overloaded. Excessive speed, underinflation, or excessive loading, either separately or in combination, can cause heat buildup and possible tire failure.

TIRES

Tires are designed to give many thousands of miles of service, but they must be maintained in order to get the maximum benefit from them.

Glossary of tire terminology

- **Tire label:** A label showing the OE (Original Equipment) tire sizes, recommended inflation pressure and the maximum weight the vehicle can carry.
- **Tire Identification Number (TIN):** A number on the sidewall of each tire providing information about the tire brand and manufacturing plant, tire size and date of manufacturer.
- **Inflation pressure:** A measure of the amount of air in a tire.
- **Standard load:** A class of P-metric or Metric tires designed to carry a maximum load at 35 psi [37 psi (2.5 bar) for Metric tires]. Increasing the inflation pressure beyond this pressure will not increase the tires load carrying capability.
- **Extra load:** A class of P-metric or Metric tires designed to carry a heavier maximum load at 41 psi [43 psi (2.9 bar) for Metric tires]. Increasing the inflation pressure beyond this pressure will not increase the tires load carrying capability.
- **kPa:** Kilopascal, a metric unit of air pressure.
- **PSI:** Pounds per square inch, a standard unit of air pressure.
- **B-pillar:** The structural member at the side of the vehicle behind the front door.

Maintenance and Specifications

- **Bead area of the tire:** Area of the tire next to the rim.
- **Sidewall of the tire:** Area between the bead area and the tread.
- **Tread area of the tire:** Area of the perimeter of the tire that contacts the road when mounted on the vehicle.
- **Rim:** The metal support (wheel) for a tire or a tire and tube assembly upon which the tire beads are seated.

INFORMATION CONTAINED ON THE TIRE SIDEWALL

Federal law requires tire manufacturers to place standardized information on the sidewall of all tires. This information identifies and describes the fundamental characteristics of the tire and also provides a U.S. DOT Tire Identification Number for safety standard certification and in case of a recall.

Information on “P” type tires

P215/65R15 95H is an example of a tire size, load index and speed rating. The definitions of these items are listed below. (Note that the tire size, load index and speed rating for your vehicle may be different than this example.)

1. **P:** Indicates a tire, designated by the Tire and Rim Association (T&RA), that may be used for service on cars, SUVs, minivans and light trucks.

Note: If your tire size does not begin with a letter this may mean it is designated by either ETRTO (European Tire and Rim Technical Organization) or JATMA (Japan Tire Manufacturing Association).

2. **215:** Indicates the nominal width of the tire in millimeters from sidewall edge to sidewall edge. In general, the larger the number, the wider the tire.

3. **65:** Indicates the aspect ratio which gives the tire’s ratio of height to width.

4. **R:** Indicates a “radial” type tire.

5. **15:** Indicates the wheel or rim diameter in inches. If you change your wheel size, you will have to purchase new tires to match the new wheel diameter.

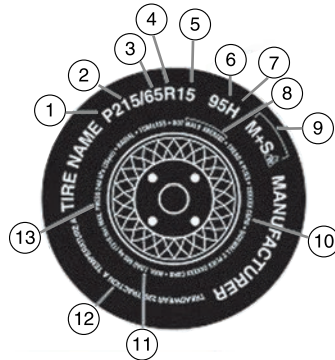

Maintenance and Specifications

6. **95:** Indicates the tire's load index. It is an index that relates to how much weight a tire can carry. You may find this information in your owner's guide. If not, contact a local tire dealer.

Note: You may not find this information on all tires because it is not required by federal law.

7. **H:** Indicates the tire's speed rating. The speed rating denotes the speed at which a tire is designed to be driven for extended periods of time under a standard condition of load and inflation pressure. The tires on your vehicle may operate at different conditions for load and inflation pressure. These speed ratings may need to be adjusted for the difference in conditions. The ratings range from 159 km/h (99 mph) to 299 km/h (186 mph). These ratings are listed in the following chart.

Note: You may not find this information on all tires because it is not required by federal law.

Letter rating	Speed rating - km/h (mph)
Q	159 km/h (99 mph)
R	171 km/h (106 mph)
S	180 km/h (112 mph)
T	190 km/h (118 mph)
U	200 km/h (124 mph)
H	210 km/h (130 mph)
V	240 km/h (149 mph)
W	270 km/h (168 mph)
Y	299 km/h (186 mph)

Note: For tires with a maximum speed capability over 240 km/h (149 mph), tire manufacturers sometimes use the letters ZR. For those with a maximum speed capability over 299 km/h (186 mph), tire manufacturers always use the letters ZR.

8. **U.S. DOT Tire Identification Number (TIN):** This begins with the letters "DOT" and indicates that the tire meets all federal standards. The next two numbers or letters are the plant code where it was manufactured, the next two are the tire size code and the last four numbers represent the week and year the tire was built. For example, the numbers 317 mean the 31st week of 1997. After 2000 the numbers go to four digits. For example, 2501 means the 25th week of 2001. The numbers in between are marketing codes used at the manufacturer's discretion. This information is used to contact customers if a tire defect requires a recall.

Maintenance and Specifications

9. **M+S or M/S:** Mud and Snow. or

AT: All Terrain. or

AS: All Season.

10. **Tire Ply Composition and Material Used:** Indicates the number of plies or the number of layers of rubber-coated fabric in the tire tread and sidewall. Tire manufacturers also must indicate the ply materials in the tire and the sidewall, which include steel, nylon, polyester, and others.

11. **Maximum Load:** Indicates the maximum load in kilograms and pounds that can be carried by the tire. Refer to the tire label or the safety certification label, located on the B-Pillar or the driver's door, for the correct tire pressure for your vehicle

12. Treadwear, Traction and Temperature Grades

- **Treadwear:** The treadwear grade is a comparative rating based on the wear rate of the tire when tested under controlled conditions on a specified government test course. For example, a tire graded 150 would wear one and one-half (1½) times as well on the government course as a tire graded 100.
- **Traction:** The traction grades, from highest to lowest are AA, A, B, and C. The grades represent the tire's ability to stop on wet pavement as measured under controlled conditions on specified government test surfaces of asphalt and concrete. A tire marked C may have poor traction performance.
- **Temperature:** The temperature grades are A (the highest), B and C, representing the tire's resistance to the generation of heat and its ability to dissipate heat when tested under controlled conditions on a specified indoor laboratory test wheel.

13. **Maximum Permissible Inflation Pressure:** Tire manufactures maximum permissible pressure and/or the pressure at which the maximum load can be carried by the tire. This pressure is normally higher than the manufacturer's recommended cold inflation pressure which can be found on either the tire label or certification label which is located on the structure by the trailing edge of the driver's door or the edge of the driver's door. The cold inflation pressure should never be set lower than the recommended pressure on the vehicle label.

Note: You may not find this information on all tires because it is not required by federal law.

The tire suppliers may have additional markings, notes or warnings such as standard load, radial tubeless, etc.

200

2004 Focus (foc)
Owners Guide (post-2002-fmt)
USA English (fus)

Maintenance and Specifications

Additional information contained on the tire sidewall for “LT” type tires

“LT” type tires have some additional information than those of “P” type tires; these differences are described below:

1. **LT:** Indicates a tire, designated by the Tire and Rim Association (T&RA), that is intended for service on light trucks.

2. **Load Range/Load Inflation Limits:** Indicates the tires load-carrying capabilities and its inflation limits.

3. **Maximum Load Dual kg (lbs.)**

at kPa (psi) cold: Indicates the maximum load and tire pressure when the tire is used as a dual; a dual is defined as when four tires are put on the rear axle (a total of six or more tires on the vehicle).

4. **Maximum Load Single kg (lbs.) at kPa (psi) cold:** Indicates the maximum load and tire pressure when the tire is used as a single; a single is defined as when two tires (total) are put on the rear axle.

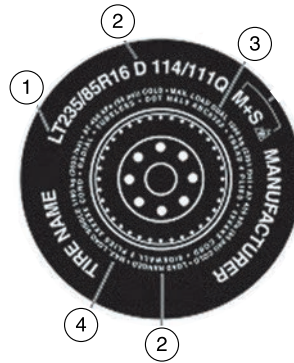

Maintenance and Specifications

Information on “T” type tires

T145/80D16 is an example of a tire size.

Note: The temporary tire size for your vehicle may be different than this example.

1. **T:** Indicates a type of tire, designated by the Tire and Rim Association (T&RA), that is intended for temporary service on cars, SUVs, minivans and light trucks.

2. **145:** Indicates the nominal width of the tire in millimeters from sidewall edge to sidewall edge. In general, the larger the number, the wider the tire.

3. **80:** Indicates the aspect ratio which gives the tires ratio of height to width. Numbers of 70 or lower indicate a short sidewall.

4. **D:** Indicates a “diagonal” type tire.

R: Indicates a “radial” type tire.

5. **16:** Indicates the wheel or rim diameter in inches. If you change your wheel size, you will have to purchase new tires to match the new wheel diameter.

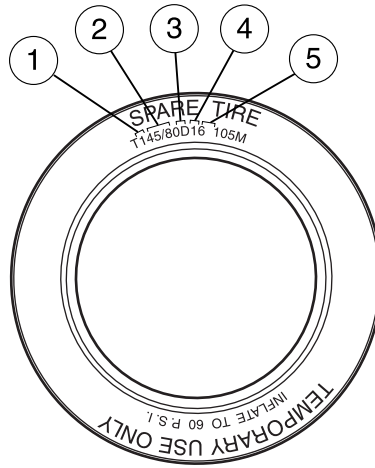

Location of the tire label

You will find a tire label containing tire inflation pressure by tire size and other important information located on the B-Pillar or the driver's door.

TIRE CARE

Improper or inadequate vehicle maintenance can also cause tires to wear abnormally. Here are some of the important maintenance items:

Tire inflation pressure

Use a tire gauge to check the tire inflation pressure, including the spare, at least monthly and before long trips. You are strongly urged to buy a reliable tire pressure gauge, as automatic service station gauges may be inaccurate. Ford recommends the use of a digital or dial type tire pressure gauge rather than a stick type tire pressure gauge.

202

2004 Focus (foc)
Owners Guide (post-2002-fmt)
USA English (fus)

Maintenance and Specifications

Use the recommended cold inflation pressure for optimum tire performance and wear. Under-inflation or over-inflation may cause uneven treadwear patterns.



Under-inflation is the most common cause of tire failures and may result in severe tire cracking, tread separation or "blowout", with unexpected loss of vehicle control and increased risk of injury. Under-inflation increases sidewall flexing and rolling resistance, resulting in heat buildup and internal damage to the tire. It also may result in unnecessary tire stress, irregular wear, loss of vehicle control and accidents. A tire can lose up to half of its air pressure and not appear to be flat!

When weather temperature changes occur, tire inflation pressures also change. A 6° C (10° F) temperature change can cause a corresponding drop of 7 kPa (1 psi) in inflation pressure. Check your tire pressures frequently and adjust them to the proper pressure which can be found on the tire label or certification label.

If you are checking tire pressure when the tire is hot, (i.e. driven more than 1.6 km [1mile]), never "bleed" or reduce air pressure. The tires are hot from driving and it is normal for pressures to increase above recommended cold pressures. A hot tire at or below recommended cold inflation pressure could be significantly under-inflated.

To check the pressure in your tire(s):

1. Make sure the tires are cool, meaning they are not hot from driving even a mile.

Note: If you have to drive a distance to get air for your tire(s), check and record the tire pressure first and add the appropriate air pressure when you get to the pump. It is normal for tires to heat up and the air pressure inside to go up as you drive. Never "bleed" or reduce air pressure when tires are hot.

2. Remove the cap from the valve on one tire, then firmly press the tire gauge onto the valve.

3. Add air to reach the recommended air pressure

Note: If you overfill the tire, release air by pushing on the metal stem in the center of the valve. Then recheck the pressure with your tire gauge.

4. Replace the valve cap.

5. Repeat this procedure for each tire, including the spare.

Note: Some spare tires require higher inflation pressure than the other tires. Check the tire label on the B pillar or the driver's door for the recommended spare tire pressure.

Maintenance and Specifications

6. Visually inspect the tires to make sure there are no nails or other objects embedded that could poke a hole in the tire and cause an air leak.
7. Check the sidewalls to make sure there are no gouges, cuts, bulges or other irregularities.

Tire and wheel alignment

A bad jolt from hitting a curb or pothole can cause the front end of your vehicle to become misaligned or damage to your tires. If your vehicle seems to pull to one side when you're driving, the wheels may be out of alignment. Have a qualified technician at a Ford or Lincoln/Mercury dealer check the wheel alignment periodically.

Wheel misalignment in the front or the rear can cause uneven and rapid treadwear of your tires and should be corrected by a qualified technician at a Ford or Lincoln/Mercury dealer. Front wheel drive (FWD) vehicles, and those with an independent rear suspension require alignment of all four wheels.

The tires should also be balanced periodically. An unbalanced tire and wheel assembly may result in irregular tire wear.

Tire rotation

Rotating your tires at the recommended interval (as indicated in the *Scheduled Maintenance Guide* that comes with your vehicle) will help your tires wear more evenly providing better tire performance and longer tire life. Unless otherwise specified, rotate the tires approximately every 8,000 km (5,000 miles).

Maintenance and Specifications

- Front Wheel Drive (FWD) vehicles (front tires at top of diagram)

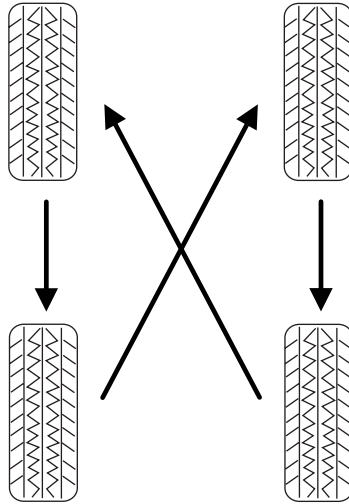

- Rear Wheel Drive (RWD) vehicles/Four Wheel Drive (4WD) vehicles (front tires at top of diagram)

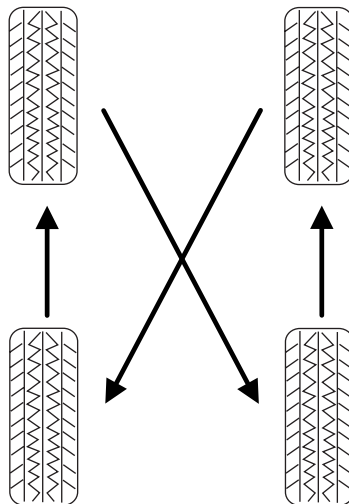

Sometimes irregular tire wear can be corrected by rotating the tires.

Maintenance and Specifications

Note: If your tires show uneven wear ask a qualified technician at a Ford or Lincoln/Mercury dealership to check for and correct any wheel misalignment, tire imbalance or mechanical problem involved before tire rotation.

Note: Your vehicle may be equipped with a dissimilar spare tire/wheel. A dissimilar spare tire/wheel is defined as a spare tire and/or wheel that is different in brand, size or appearance from the road tires and wheels. If you have a dissimilar spare tire/wheel it is intended for temporary use only and should not be used in a tire rotation.

Note: After having your tires rotated, inflation pressure must be checked and adjusted to the vehicle requirements.

Tire wear

Measure and inspect the tire tread on all your tires periodically. Advanced and unusual tire wear can reduce the ability of tread to grip the road in adverse (wet, snowy, etc.) conditions. Visually check your tires for uneven wear, looking for high and low areas or unusually smooth areas. Also check for signs of tire damage.

When the tread is worn down to 1/16th of an inch, tires must be replaced to prevent your vehicle from skidding and hydroplaning. Built-in treadwear indicators, or “wear bars”, which look like narrow strips of smooth rubber across the tread will appear on the tire when the tread is worn down to 4mm (1/16th of an inch). When you see these “wear bars”, the tire is worn out and should be replaced.

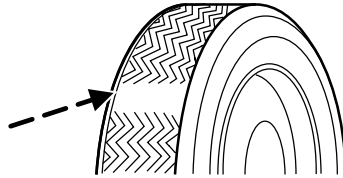

Inspect your tires frequently for any of the following conditions and replace them if one or more of the following conditions exist:

- Fabric showing through the tire rubber
- Bulges in the tread or sidewalls
- Cracks or cuts on the sidewalls
- Cracks in the tread groove
- Impact damage resulting from use
- Separation in the tread
- Separation in the sidewall
- Severe abrasion on the sidewall

206

2004 Focus (foc)
Owners Guide (post-2002-fmt)
USA English (fus)

Maintenance and Specifications

If your vehicle has a leak in the exhaust system, a road tire or the spare tire may be exposed to hot exhaust temperatures requiring the tire to be replaced.

Tire Replacement Requirements

Your vehicle is equipped with tires designed to provide safe ride and handling capability.



Only use replacement tires and wheels that are the same size and type (such as P-metric versus LT-metric or all-season versus all-terrain) as those originally provided by Ford. Use of any tire or wheel not recommended by Ford can affect the safety and performance of your vehicle, which could result in an increased risk of loss of vehicle control, vehicle rollover, personal injury and death. Additionally the use of non-recommended tires and wheels could cause steering, suspension, axle or transfer case/power transfer unit failure. If you have questions regarding tire replacement, see an authorized Ford or Lincoln/Mercury dealer.

Make sure all tires and wheels on the vehicle are of the same size, type, tread design, brand, load-carrying capacity and speed rating because it can affect the safety and performance of your vehicle, which could result in an increased risk of loss of vehicle control, vehicle rollover, personal injury and death.

You should replace the spare tire when you replace the other road tires due to the aging of the spare tire.

Safety practices

Driving habits have a great deal to do with your tire mileage and safety.

- Observe posted speed limits
- Avoid fast starts, stops and turns
- Avoid potholes and objects on the road
- Do not run over curbs or hit the tire against a curb when parking

If your vehicle is stuck in snow, mud, sand, etc., **do not** rapidly spin the tires; spinning the tires can tear the tire and cause an explosion. A tire can explode in as little as three to five seconds.



Tire explosions can cause death, personal injury or property damage. Do not allow anyone to stand near, directly ahead or behind the spinning tire.

Maintenance and Specifications



Never spin the tires in excess of the 55 km/h (35 mph) point indicated on the speedometer.

Highway hazards

No matter how carefully you drive there's always the possibility that you may eventually have a flat tire on the highway. Drive slowly to the closest safe area out of traffic. This may further damage the flat tire, but your safety is more important.

If you feel a sudden vibration or ride disturbance while driving, or you suspect your tire or vehicle has been damaged, immediately reduce your speed. Drive with caution until you can safely pull off the road. Stop and inspect the tire for damage. If the tire is under-inflated or damaged, deflate it, remove wheel and replace it with your spare tire and wheel. If you cannot detect a cause, have the vehicle towed to the nearest repair facility or tire dealer to have the vehicle inspected.

SNOW TIRES AND CHAINS



Snow tires must be the same size and grade as the tires you currently have on your vehicle.

The tires on your vehicle have all weather treads to provide traction in rain and snow. However, in some climates, you may need to use snow tires and chains. If you need to use chains, it is recommended that steel wheels (of the same size and specifications) be used, as chains may chip aluminum wheels.

Vehicles with Traction Control (if equipped) may exhibit some unusual driving characteristics, when using snow chains, which can be avoided by switching Traction Control off.

Follow these guidelines when using snow tires and chains:

Snow chains should only be fitted to size P 185/65 R14 tires.

Snow chains should never be used on the spare tire.

- Use only SAE Class S chains.
- Install chains securely, verifying that the chains do not touch any wiring, brake lines or fuel lines.
- Drive cautiously. If you hear the chains rub or bang against your vehicle, stop and re-tighten the chains. If this does not work, remove the chains to prevent damage to your vehicle.
- If possible, avoid fully loading your vehicle.

208

2004 Focus (foc)
Owners Guide (post-2002-fmt)
USA English (fus)

Maintenance and Specifications

- Remove the tire chains when they are no longer needed. Do not use tire chains on dry roads.
- The suspension insulation and bumpers will help prevent vehicle damage. Do not remove these components from your vehicle when using snow tires and chains.

MOTORCRAFT PART NUMBERS

Component	2.0L I4 SPI engine	2.0L I4 Zetec-E engine	2.3L I4 PZEV engine
Air filter element	FA-1688	FA-1688	N/A (Lifetime) ¹
Fuel filter	FG-986-B	FG-986-B	FG-1081
Oil filter	FL-400-S	FL-2005	FL-910
Battery	BXT-40R	BXT-96R	BXT-96R
PCV valve	²		
Spark plugs-platinum	³		

¹ Non Serviceable Part. Air Filter Service Minder indicates if service is needed. See dealer or qualified technician for replacement. The air filter is designed as a “lifetime” part.

²The PCV valve is a critical emission component. It is one of the items listed in the *Scheduled Maintenance Guide* and is essential to the life and performance of your vehicle and to its emissions system.

For PCV valve replacement, see your dealer or a qualified service technician. Refer to the *Scheduled Maintenance Guide* for the appropriate intervals for changing the PCV valve.

Replace the PCV valve with one that meets Ford material and design specifications for your vehicle, such as a Motorcraft or equivalent replacement part. The customer warranty may be void for any damage to the emissions system if such a PCV valve is not used.

³For spark plug replacement, see your dealer or a qualified service technician. Refer to the *Scheduled Maintenance Guide* for the appropriate intervals for changing the spark plugs.

Replace the spark plugs with ones that meet Ford material and design specifications for your vehicle, such as Motorcraft or equivalent replacement parts. The customer warranty may be void for any damage to the engine if such spark plugs are not used.

Refer to Vehicle Emissions Control Information (VECI) decal for spark plug gap information.

Maintenance and Specifications

REFILL CAPACITIES

Fluid	Ford Part Name	Application	Capacity
Brake fluid and clutch fluid	Motorcraft High Performance DOT 3 Motor Vehicle Brake Fluid	All	Fill to line on reservoir
Engine coolant ¹	Motorcraft Premium Gold Engine Coolant (yellow-colored)	2.0L SPI engine	5.75L (6.1 quarts)
		2.0L Zetec E engine	5.75L (6.1 quarts)
		2.3L engine	5.75L (6.1 quarts)
Engine oil (includes filter change) ⁴	Motorcraft SAE 5W-20 Premium Synthetic Blend Motor Oil (US) Motorcraft SAE 5W-20 Super Premium Motor Oil (Canada)	2.0L SPI engine	3.78L (4.0 quarts)
		2.0L Zetec E engine	4.25L (4.5 quarts)
		2.3L engine	4.3L (4.54 quarts)
Fuel tank	N/A	2.0L SPI and 2.0L Zetec E	50L (13.2 gallons)
		2.3L	53L (14.0 gallons)
Power steering fluid	Motorcraft MERCON® ATF	All	Fill to between MIN and MAX lines on reservoir

Maintenance and Specifications

Fluid	Ford Part Name	Application	Capacity
Transaxle fluid ²	Motorcraft Full Synthetic Manual Transmission Fluid	5-speed manual	2.0L (2.1 quarts) ³
	Motorcraft MERCON® V ATF	Automatic	6.6L (6.9 quarts) ³
Windshield washer fluid	Motorcraft Premium Windshield Washer Concentrate	Sedan	2.5L (2.6 quarts)
		Coupe and Wagon	4.0L (4.2 quarts)

¹Add the coolant type originally equipped in your vehicle.

²Ensure the correct automatic transmission fluid is used. Transmission fluid requirements are indicated on the dipstick or on the dipstick handle or as listed in the Owner Guide. Check the container to verify the fluid being added is of the correct type. Refer to your *Scheduled Maintenance Guide* to determine the correct service interval.

Some transmission fluids may be labeled as dual usage, such as MERCON® and MERCON® V. These dual usage fluids are not to be used in an automatic transmission that requires use of the MERCON® type fluid. However, these dual usage fluids may be used in transmissions that require the MERCON® V type fluid.

MERCON® and MERCON® V type fluids are not interchangeable. DO NOT mix MERCON® and MERCON® V. Use of a transmission fluid that indicates dual usage (MERCON® and MERCON® V) in an automatic transmission application requiring MERCON® may cause transmission damage. Use of any fluid other than the recommended fluid may cause transmission damage.

³Approximate dry fill capacity including transmission fluid cooling system, actual refill capacities will vary based on vehicle application and transmission fluid cooling system (i.e. coolers size, cooling lines, auxiliary cooler capacities). The amount of transmission fluid and fluid level should be set by the indication on the dipstick's normal operating range.

Maintenance and Specifications

The manual transmission service refill capacity is determined by filling the transaxle to the bottom of the filler hole with the vehicle on a level surface.

⁴Use of synthetic or synthetic blend motor oil is not mandatory. Engine oil need only meet the requirements of Ford specification WSS-M2C153-H and the API Certification mark.

LUBRICANT SPECIFICATIONS

Item	Ford Part Name or Equivalent	Ford Part Number	Ford Specification
Brake fluid	Motorcraft High Performance DOT 3 Motor Vehicle Brake Fluid	PM-1	ESA-M6C25-A and DOT 3
Door latch, hood latch, auxiliary hood latch, trunk latch, seat tracks.	Multi-Purpose Grease	XG-4 or XL-5	ESR-M1C159-A or ESB-M1C93-B
Lock cylinder	Penetrating and Lock Lubricant	XL-1	none
Automatic transaxle	Motorcraft MERCON® V ATF	XT-5-QM	MERCON® V
Manual transaxle	Motorcraft Full Synthetic Manual Transmission Fluid	XT-M5-QS	WSD-M2C200-C

Maintenance and Specifications

Item	Ford Part Name or Equivalent	Ford Part Number	Ford Specification
Engine oil	Motorcraft SAE 5W-20 Premium Synthetic Blend Motor Oil (US) Motorcraft SAE 5W-20 Super Premium Motor Oil (Canada)	XO-5W20-QSP (US) CXO-5W20-LSP12 (Canada)	WSS-M2C153-H and API Certification Mark
Constant velocity joints	CV Joint Grease (High Temp.)	XG-5	WSS-M1C258-A1
Engine coolant	Motorcraft Premium Gold Engine Coolant (yellow-colored)	VC-7-A (U.S., except CA and OR), VC-7-B (CA and OR only)	WSS-M97B51-A1
Power steering fluid	Motorcraft MERCON® ATF	XT-2-QDX	MERCON®
Windshield washer fluid	Motorcraft Windshield Washer Concentrate	ZC-32-A	WSB-M8B16-A2

ENGINE DATA

Engine	2.0L SPI engine	2.0L Zetec E engine	2.3L I4 engine
Cubic inches	121	121	138
Required fuel	87 octane	87 octane	87 octane
Firing order	1-3-4-2	1-3-4-2	1-3-4-2
Ignition system	Electronic Ignition	Electronic Ignition	C.O.P.
Compression ratio	9.35:1	9.6:1	9.7:1

Maintenance and Specifications

VEHICLE DIMENSIONS

Vehicle dimensions	Sedan mm (in)	Coupe mm (in)	Wagon mm (in)
(1) Overall length	4440 (174.8)	4269 (168.1)	4523 (178.1)
(2) Overall width	1988 (78.3)	1988 (78.3)	1988 (78.3)
(3) Overall height	1474 (58.0)	1474 (58.0)	1493 (58.8) ¹
(4) Wheelbase	2615 (103)	2615 (103)	2615 (103)
(5) Track - Front	1494 (58.8)	1494 (58.8)	1494 (58.8)
(5) Track - Rear	1487 (58.5)	1487 (58.5)	1487 (58.5)

¹Overall height with roof rack is 1533 (60.4)

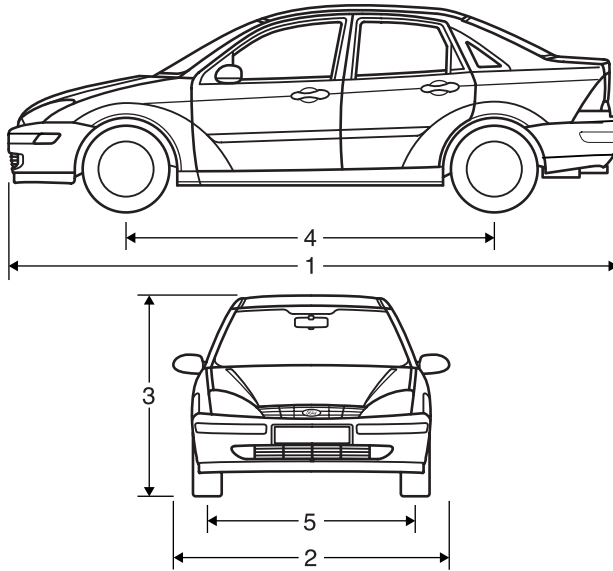

- Sedan

Maintenance and Specifications

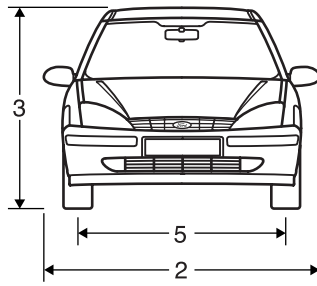
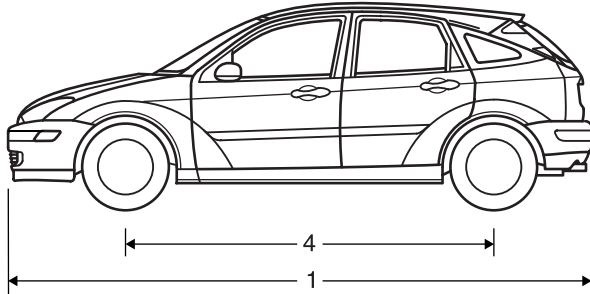
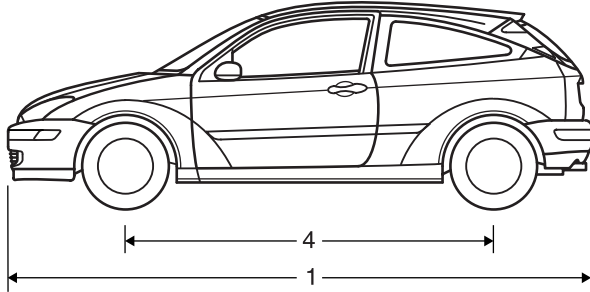

- Coupe

Maintenance and Specifications

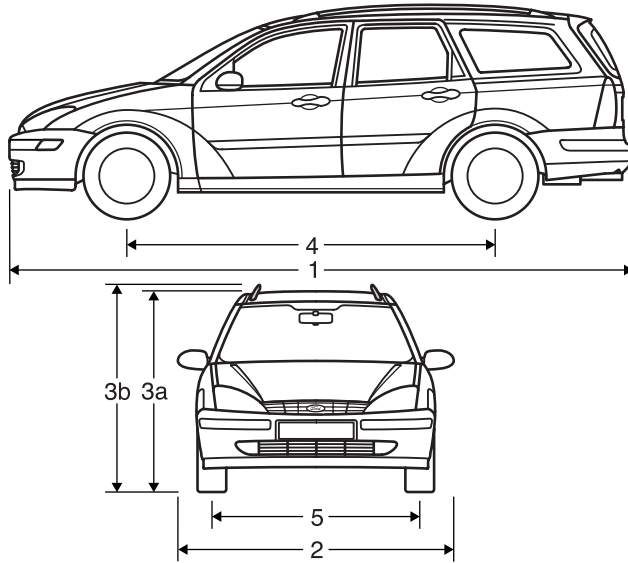

- Wagon

IDENTIFYING YOUR VEHICLE

Certification label

The National Highway Traffic Safety Administration Regulations require that a Certification label be affixed to a vehicle and prescribe where the Certification label may be located. The Certification label is located on the front door latch pillar on the driver's side.

MFD. BY FORD MOTOR CO. IN U.S.A.	
DATE: XXXXX	GVWR: XXXXX LB/ XXXXX KG
FGAWR: XXXXXX/XXXXXXXX	RGAWR: XXXXXX/XXXXXXXX
THIS VEHICLE CONFORMS TO ALL APPLICABLE FEDERAL MOTOR VEHICLE SAFETY STANDARDS IN EFFECT ON THE DATE OF MANUFACTURE SHOWN ABOVE.	
VIN: XXXXXXXXXXXXXXXXX	TYPE: XXXXXXXXXXXXXXXXX
MAXIMUM LOAD=OCCUPANTS + LUGGAGE= XXXKG/XXXLB	
OCCUPANTS: X TOTAL X FR X 2ND X RR OCCUPANTS LUGGAGE	
XX XXXKG/XXXLB	
X XXXKG/XXXLB	
TIRE: XXXX/XXXXX XXX	
PRESSURE (FR) XXX kPa/ XX PSI COLD	
PRESSURE (RR) XXX kPa/ XX PSI COLD	
TRAILER TOWING - SEE OWNER GUIDE	
EXT PNT: XXXXX XXXXX	RC: XX DSO: XXXX F000
BAR INT TR TP/PS R	AXLE TR SPR T0000
X XX XXX X	XX X XXXX
UTC VFOHT-15294A10-GA	

Maintenance and Specifications

Vehicle identification number (VIN)

The vehicle identification number is attached to a metal tag and is located on the driver side instrument panel. (Please note that in the graphic XXXX is representative of your vehicle identification number.)

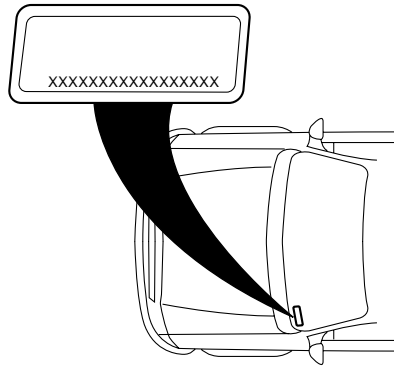

1. World manufacturer identifier
2. Brake type and gross vehicle weight rating (GVWR)
3. Vehicle line, series, body type
4. Engine type
5. Check digit
6. Model year
7. Assembly plant
8. Production sequence number

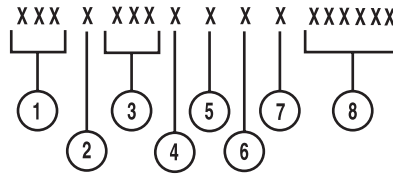

Engine number

The engine number (the last eight numbers of the vehicle identification number) is stamped on the engine block, transaxle, and frame.

Maintenance and Specifications

Transmission/Transaxle code designations

MFD. BY FORD MOTOR CO. IN U.S.A.									
DATE: XX/XX	GVWR: XXXXXLB/ XXXXXKG								
FRONT GAWR: XXXXL	WITH XXXXKG		REAR GAWR: XXXXLB						
XXXXXX	TRES		XXXXXX						
XXXXXX	RIMS		XXXXXX						
AT XXX kPa/XX	PSI COLD		AT XXX kPa/XX		PSI COLD				
THIS VEHICLE CONFORMS TO ALL APPLICABLE FEDERAL MOTOR VEHICLE SAFETY AND THEFT PREVENTION STANDARDS IN EFFECT ON THE DATE OF MANUFACTURE SHOWN ABOVE.									
VIN: XXXXXXXXXXXXXXXXX	XXXXX				XXXXX				
TYPE: XXX									
EXT PNT: XX	RC: XX		DSO:						
WB BRK INT TR TP/PS R AXLE TR SPR	XXXXX								
XXX X XX X XX X XX	XXXXX								
XXXXXXXXXXXXX UTC *2USA-1520472-AA									

You can find a transmission/transaxle code on the vehicle certification label which is located on the door pillar. The following table tells you which transmission or transaxle each code represents.

Truck application:

Code	Transmission Description
	<i>Manual transmission</i>
M	Manual 5-speed (AKK)
C	Manual 5-speed overdrive (Close ratio)
W	Manual 5-speed overdrive (Dana ZF)
G	Manual 6-speed ZF
	<i>Automatic transmission</i>
Y	Automatic 4-speed overdrive (CD4E)
U	Automatic 4-speed overdrive (4R70W)
T	Automatic 4-speed overdrive (4R44E)
E	Automatic 4-speed overdrive (4R100)
J	Automatic 5-speed overdrive (5R55E)

Maintenance and Specifications

Code	Transmission Description
	<i>Electric</i>
H	One speed electric
D	Automatic 5-speed overdrive (5R44E)
R	Automatic 5-speed overdrive (5R55S)

Passenger car application:

Code	Transmission/Transaxle Description
	<i>Front wheel drive manual transaxle</i>
R	5-speed overdrive (MTX75)
W	5-speed overdrive (M5)
	<i>Front wheel drive automatic transaxle</i>
A	4-speed overdrive (4F27E)
E	4-speed overdrive (4FE)
J	3-speed (Mazda)
L	4-speed overdrive (AX4S)
P	4-speed overdrive (4F20E)
X	4-speed overdrive (4F50N)
Y	4-speed overdrive (CD4E)
	<i>Rear wheel drive manual transaxle</i>
5	5-speed (Mazda M5)
	<i>Rear wheel drive automatic transmission</i>
U	4-speed overdrive (4R70W)
A	5-speed overdrive (5R55N)

Accessories

GENUINE FORD ACCESSORIES FOR YOUR VEHICLE

A wide selection of Genuine Ford Accessories are available for your vehicle through your local authorized Ford or Ford of Canada dealer. These quality accessories have been specifically engineered to fulfill your automotive needs; they are custom designed to complement the style and aerodynamic appearance of your vehicle. In addition, each accessory is made from high quality materials and meets or exceeds Ford's rigorous engineering and safety specifications. Ford Motor Company will repair or replace any properly dealer-installed Genuine Ford Accessory found to be defective in factory-supplied materials or workmanship during the warranty period, as well as any component damaged by the defective accessory. The accessory will be warranted for whichever provides you the greatest benefit:

- 12 months or 20,000 km (12,000 miles) (whichever occurs first), or
- the remainder of your new vehicle limited warranty.

This means that Genuine Ford Accessories purchased along with your new vehicle and installed by the dealer are covered for the full length of your New Vehicle's Limited Warranty — 3 years or 60,000 km (36,000 miles) (whichever occurs first). Contact your dealer for details and a copy of the warranty.

Not all accessories are available for all models.

The following is a list of several Genuine Ford Accessory products for your vehicle. Not all accessories are available for all models. For a complete listing of the accessories that are available for your vehicle, please contact your dealer or visit our online store at: www.fordaccessoriesstore.com.

Exterior style

Bug shields
Deflectors
Exterior trim kits
Front end covers
Grille inserts
Headlamps, fog lights and Daytime Running Lamps (DRLs)
Splash guards
Wheels

Interior style

Cell phone holders
Electrochromatic compass/temperature interior mirrors

220

2004 Focus (foc)
Owners Guide (post-2002-fmt)
USA English (fus)

Accessories

Floor mats
Interior trim kits
Leather wrapped steering wheels
Scuff plates
Speed control

Lifestyle

Bike racks
Cargo organization and management
Engine block heaters and blankets

Peace of mind

Airbag anti-theft locks
First aid and safety kits
Full vehicle covers
Locking gas cap
Navigation systems
Remote start
Vehicle security systems

For maximum vehicle performance, keep the following information in mind when adding accessories or equipment to your vehicle:

- When adding accessories, equipment, passengers and luggage to your vehicle, do not exceed the total weight capacity of the vehicle or of the front or rear axle (GVWR or GAWR as indicated on the Safety Compliance Certification label). Consult your dealer for specific weight information.
- The Federal Communications Commission (FCC) and Canadian Radio Telecommunications Commission (CRTC) regulate the use of mobile communications systems — such as two-way radios, telephones and theft alarms - that are equipped with radio transmitters. Any such equipment installed in your vehicle should comply with FCC or CRTC regulations and should be installed only by a qualified service technician.
- Mobile communications systems may harm the operation of your vehicle, particularly if they are not properly designed for automotive use.

Index

A

Air bag supplemental restraint system90, 94
and child safety seats92
description90, 94
disposal96
driver air bag92, 95
indicator light94
operation92, 95
passenger air bag92, 95
side air bag94
Air cleaner filter209
Antifreeze
(see Engine coolant)176
Anti-lock brake system
(see Brakes)112
Anti-theft system71
arming the system71
disarming a triggered system71
Automatic transaxle
fluid, adding193
fluid, checking193
fluid, specification213
Automatic transmission115
driving an automatic
overdrive116
fluid, refill capacities210
Auxiliary power point52
Axle
lubricant specifications212
refill capacities210

B

Battery174
acid, treating emergencies174
jumping a disabled battery141
maintenance-free174

replacement, specifications ...209
servicing174
BeltMinder85
Brakes112
anti-lock112
anti-lock brake system (ABS)
warning light113
fluid, checking and adding192
fluid, refill capacities210
fluid, specifications212–213
lubricant specifications ..212–213
parking113
shift interlock115

Break-in period5

C

Capacities for refilling fluids210
Cargo cover59
Cell phone use58
Certification Label216
Child safety restraints97
child safety belts97
Child safety seats100
attaching with tether straps ..104
in front seat101
in rear seat101
LATCH106
Cigar lighter
Power Point52
Cleaning your vehicle
engine compartment160
instrument panel162
interior162
plastic parts161
washing159
waxing159
wheels160
wiper blades161

Index

- Climate control (see Air conditioning or Heating)34–35
- Clutch
fluid192–193
operation while driving119
recommended shift speeds120
- Coolant
checking and adding176
refill capacities210
specifications212–213
- Cruise control
(see Speed control)54
- Customer Assistance127
Ford accessories for your
vehicle163
Ford Extended Service
Plan151
Getting assistance outside
the U.S. and Canada155
Getting roadside assistance ...127
Getting the service you
need149
Ordering additional owner's
literature156
The Dispute Settlement
Board152
Utilizing the
Mediation/Arbitration
Program155
- D**
- Daytime running lamps
(see Lamps)38
- Defrost
rear window37
- Dipstick
automatic transmission
fluid193
engine oil170
- Doors
lubricant specifications212
- Driving under special
conditions119
through water121
- E**
- Emergencies, roadside
jump-starting141
- Emission control system189
- Engine213–214
cleaning160
coolant176
idle speed control174
lubrication
specifications212–213
refill capacities210
service points167–169
starting after a collision128
- Engine block heater111
- Engine fan167
- Engine oil170
checking and adding170
dipstick170
filter, specifications173, 209
recommendations173
refill capacities210
specifications212–213
- Exhaust fumes112
- F**
- Fan, Engine Cooling167
- Floor mats59
- Fluid capacities210
- Foglamps38

Index

- Fuel182
calculating fuel economy186
cap184
capacity210
choosing the right fuel184
comparisons with EPA fuel
economy estimates189
detergent in fuel185
filling your vehicle with
fuel182, 184, 186
filter, specifications186, 209
fuel pump shut-off switch128
improving fuel economy186
octane rating185, 213–214
quality185
running out of fuel186
safety information relating to
automotive fuels182
- Fuel pump shut-off switch128
- Fuses129–130
- G**
- Gas cap (see Fuel cap)184
- Gas mileage
(see Fuel economy)186
- Gauges14
- H**
- Hazard flashers128
- Headlamps38
aiming40
bulb specifications43
daytime running lights38
flash to pass39
high beam39
turning on and off38
- Heating
heater only system34
- Hood166
- I**
- Ignition108, 213–214
- Infant seats
(see Safety seats)100
- Inspection/maintenance (I/M)
testing191
- Instrument panel
cleaning162
cluster10
lighting up panel and
interior39
- J**
- Jump-starting your vehicle141
- K**
- Keyless entry system
autolock62
- Keys
positions of the ignition108
- L**
- Lamps
bulb replacement
specifications chart43
daytime running light38
fog lamps38
headlamps38
headlamps, flash to pass39
instrument panel, dimming39
interior lamps42
- Lane change indicator
(see Turn signal)42
- Liftgate60

224

2004 Focus (foc)
Owners Guide (post-2002-fmt)
USA English (fus)

Index

- Lights, warning and indicator10
 anti-lock brakes (ABS)113
- Load limits121
- Locks
 autolock62
 childproof63
- Lubricant specifications ...212–213
- M**
- Manual transaxle
 lubricant specifications213
- Manual transmission119
 fluid capacities210
 reverse120
- Mirrors53
 side view mirrors (power)53
- Moon roof57
- Motorcraft parts186, 209
- O**
- Octane rating185
- Oil (see Engine oil)170
- P**
- Parking brake113
- Parts (see Motorcraft parts)209
- Power distribution box
(see Fuses)133
- Power Point
 Cigar lighter52
- Power steering115
 fluid, checking and adding192
 fluid, refill capacity210
 fluid, specifications212–213
- Power Windows53
- R**
- Rear window defroster37
- Relays129
- Remote entry system65
 locking/unlocking doors62
 opening the trunk66
- Roadside assistance127
- S**
- Safety Belt Maintenance89
- Safety belts
(see Safety restraints) ..77, 80–84
- Safety defects, reporting158
- Safety restraints77, 80–84
 belt minder85
 extension assembly89
 for adults81–83
 for children96–97
 safety belt maintenance89
 warning light and chime ...84–85
- Safety seats for children100
- Seat belts
(see Safety restraints)77
- Seats72
 child safety seats100
- Servicing your vehicle165
- Spare tire
(see Changing the Tire)137
- Spark plugs,
 specifications209, 213–214
- Specification chart,
 lubricants212–213
- Speed control54

Index

- Starting your vehicle108–109, 111
 jump starting141
- Steering wheel
 tilting51
- Sunroof (moonroof)57
- T**
- Temperature control
(see Climate control)34
- Tilt steering wheel51
- Tires196–197
 alignment204
 care202
 changing137, 139
 checking the pressure202
 label202
 replacing207
 rotating204
 safety practices207
 sidewall information198
 snow tires and chains208
 spare tire138
 terminology197
 tire grades197
 treadwear196, 206
- Towing124
 recreational towing126
 trailer towing124
 wrecker148
- Traction control114
- Transaxle
 lubricant specifications213
- Transmission
 automatic operation115
- brake-shift interlock (BSI)115
- fluid, checking and adding
 (automatic)193
- fluid, checking and adding
 (manual)195
- fluid, refill capacities210
- lubricant specifications212
- manual operation119
- Trunk64
 remote release66
- Turn signal42
- V**
- Vehicle dimensions214
- Vehicle Identification Number
(VIN)217
- Vehicle loading121
- Ventilating your vehicle112
- W**
- Warning lights (see Lights)10
- Washer fluid170
- Water, Driving through121
- Windows
 power53
 rear wiper/washer50
- Windshield washer fluid and
wipers
 checking and adding fluid170
- operation50
- replacing wiper blades51
- Wrecker towing148

